



AESCULAP® AdTec® MONOPOLAR

AdTec® MONOPOLAR



For years, AESCULAP® has been actively involved in the development of laparoscopic techniques in the instruments sector, introducing products such as AdTec® single use, AdTec® needle holders as well as the Multi-Fire Clip Applier Challenger Ti-P. Here, great value has always been placed on quality, user friendliness, efficiency and customer satisfaction.

In addition, AESCULAP® offers a comprehensive package of services ranging from planning and consultancy, instrument screening as well as training and qualification up to instrument repair.

Why not enjoy the benefits of the reusable monopolar instrument line?

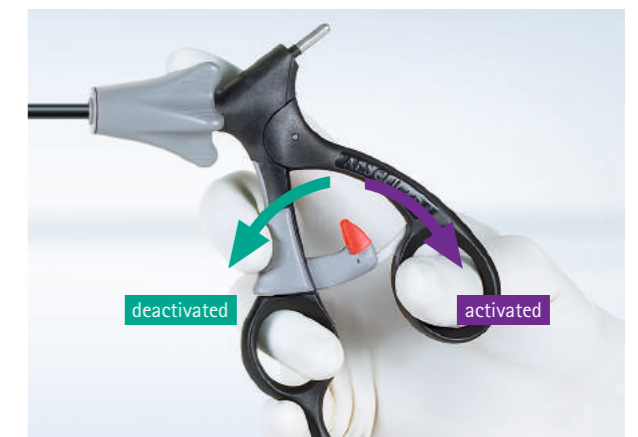

JAW MECHANISM

- Non-protruding joints during opening and closure of jaw parts (for the majority of instruments, for details see item list)
- Limits tissue or suture material that can get caught in the jaw mechanism (for the majority of instruments, for details see item list)

ONE-CLICK DESIGN

- Assembly and disassembly in one step only
- Easier handling

RATCHET MECHANISM

- Ratchet can be deactivated
- Easier handling

AdTec® MONOPOLAR

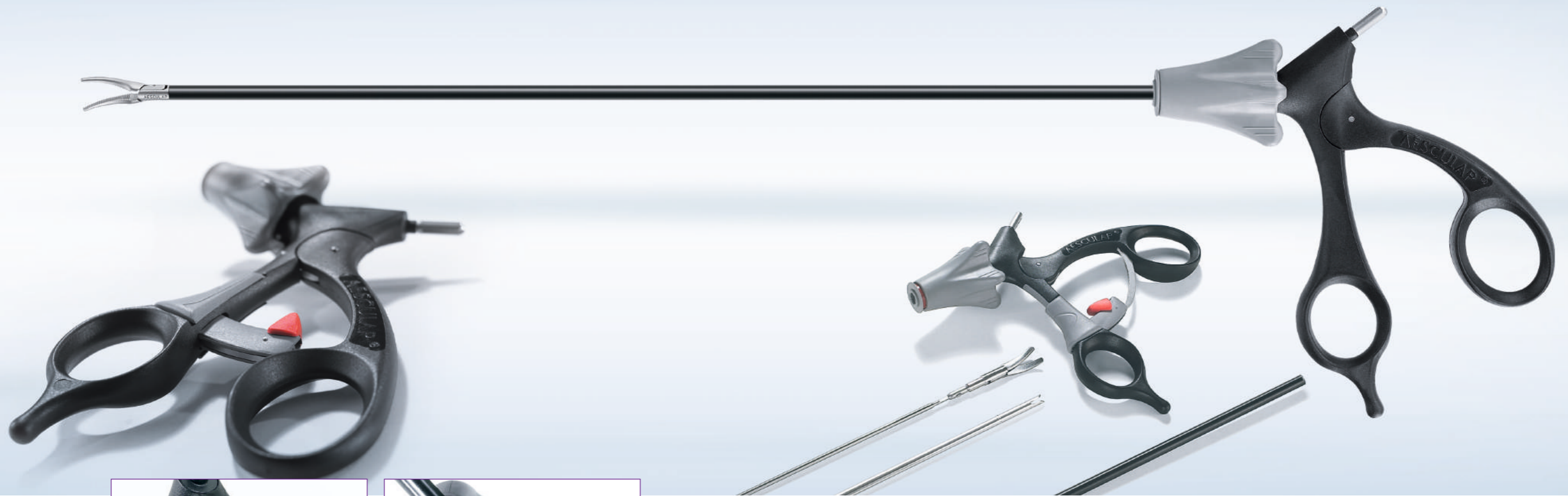

PEEK INSULATION

- Enhanced spark protection and resisting characteristic
- Quality instruments specifically designed for CSSD processing

ECONOMICAL PRICE PERFORMANCE RATIO

- Enhanced modular design aids financial benefits

UNIVERSAL

- Modular design consisting of four components, facilitating the disassembly, reprocessing, maintenance and sterile supply

STERILISATION

- Sterilisation of the assembled instrument possible

AdTec® MONOPOLAR

SCISSORS

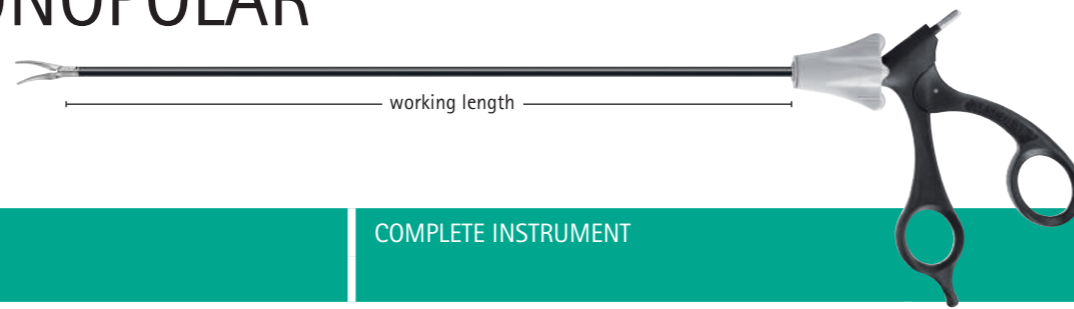

SCISSORS

	COMPLETE INSTRUMENT		SINGLE PARTS			INDIVIDUAL COMPONENTS
	Image	Description	Jaw insert	Insulated outer tube	Handle	
	PO004R	METZENBAUM Scissors, serrated, tips curved to the left, with carbide inserts	P0631R	PM970R	P0958R	PM971R Ø 5/10 mm
	PO027R	METZENBAUM Scissors, serrated, tips curved to the left, with carbide inserts	P0603R	PM973R	P0958R	PM975R Ø 5/10 mm
	PO027R	METZENBAUM Scissors, serrated, tips curved to the left, with carbide inserts	P0746R	PM981R	P0958R	
	PO022R	METZENBAUM Scissors, serrated, tips curved to left, with carbide inserts, PEEK insulation of the distal shaft Instrument with protruding jaw parts	PM697R	PM973R	P0958R	PM975R Ø 5/10 mm
	PO022R	CROCE/OLMI Dissecting and suture scissors with knot pusher	P0727R	PM973R	P0958R	PM975R Ø 5/10 mm
	PO090R	METZENBAUM Scissors, serrated, tips curved to the left, with carbide inserts Instrument with protruding jaw parts	PM604R	PM974R	P0958R	
	PO090R	Noir® METZENBAUM Scissors, serrated, tips curved to the left, with carbide inserts	P0790R	PM973R	P0958R	
	PO091R	Noir® Mini-METZENBAUM Scissors, serrated, tips curved to the left, with carbide inserts	P0791R	PM973R	P0958R	

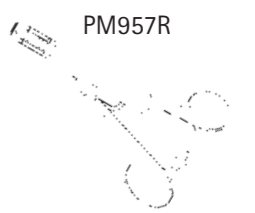
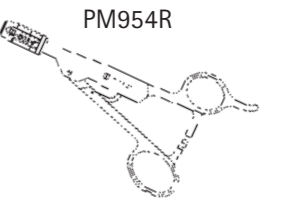
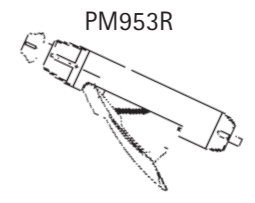
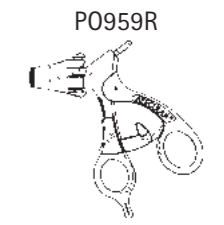
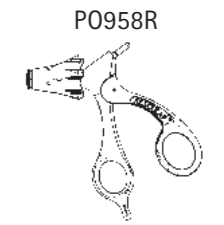

AdTec® MONOPOLAR

SCISSORS

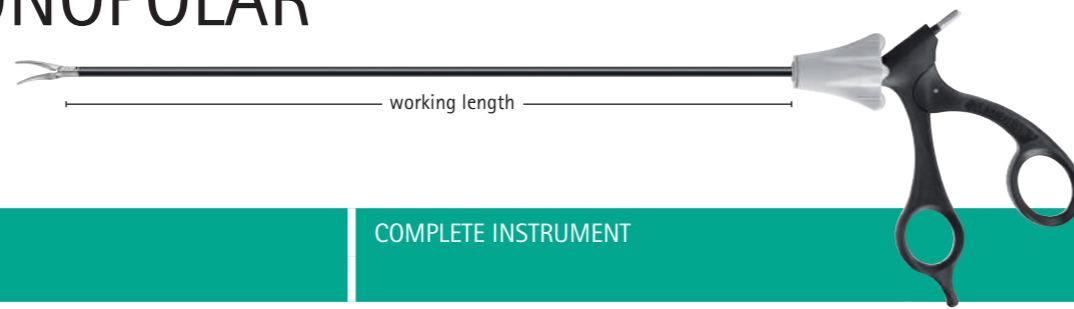









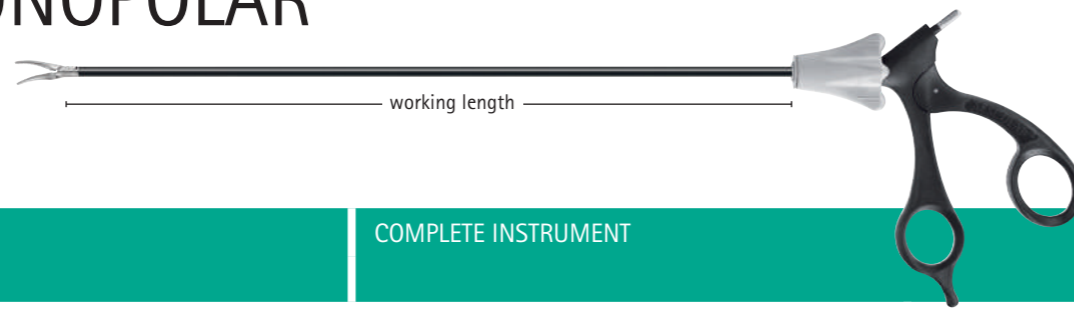



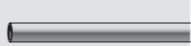
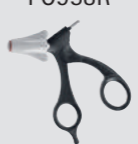

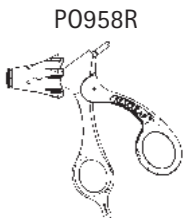

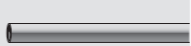

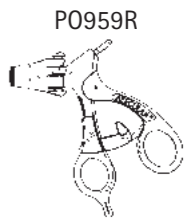



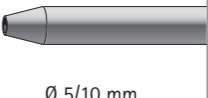
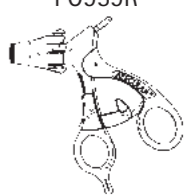





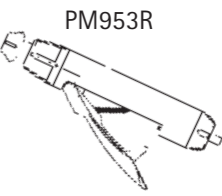

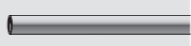

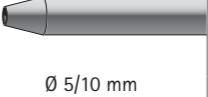
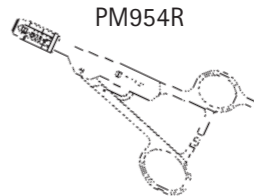
SCISSORS

	COMPLETE INSTRUMENT		SINGLE PARTS			INDIVIDUAL COMPONENTS
			Jaw insert	Insulated outer tube	Handle	
 <p>PO030R</p> <p>18 mm</p> <p>1/1</p>	<p>Medium-METZENBAUM</p> <p>Scissors, serrated, tips curved to the left, with carbide inserts</p>	5 mm / 310 mm	 <p>PO715R</p>	 <p>PM970R</p>	 <p>P0958R</p>	 <p>P0958R</p>
 <p>PO031R</p> <p>18 mm</p> <p>1/1</p>	<p>Medium-METZENBAUM</p> <p>Scissors, serrated, tips curved to the left, with carbide inserts*</p>	5 mm / 420 mm	 <p>PO716R</p>	 <p>PM981R</p>	 <p>P0958R</p>	 <p>P0959R</p>
 <p>PO023R</p> <p>14 mm</p> <p>1/1</p>	<p>Mini-METZENBAUM</p> <p>Scissors, serrated, tips curved to the left, with carbide inserts</p>	5 mm / 220 mm	 <p>PO738R</p>	 <p>PM970R</p>	 <p>P0958R</p>	 <p>PM971R</p> <p>Ø 5/10 mm</p>
 <p>PO011R</p> <p>14 mm</p> <p>1/1</p>	<p>Mini-METZENBAUM</p> <p>Scissors, serrated, tips curved to the left, with carbide inserts</p>	5 mm / 310 mm	 <p>PO655R</p>	 <p>PM973R</p>	 <p>P0958R</p>	 <p>PM975R</p> <p>Ø 5/10 mm</p>
 <p>PO028R</p> <p>14 mm</p> <p>1/1</p>	<p>Mini-METZENBAUM</p> <p>Scissors, serrated, tips curved to the left, with carbide inserts</p>	5 mm / 420 mm	 <p>PO754R</p>	 <p>PM981R</p>	 <p>P0958R</p>	 <p>PM954R</p>
 <p>13 mm</p> <p>1/1</p>	<p>Mini-METZENBAUM</p> <p>Scissors, serrated, tips curved to the left, with carbide inserts, PEEK insulation of the distal shaft</p>	10 mm / 310 mm	 <p>PM698R</p>	 <p>PM973R</p>	 <p>P0958R</p>	 <p>PM975R</p> <p>Ø 5/10 mm</p>
 <p>13 mm</p> <p>1/1</p>	<p>Mini-METZENBAUM</p> <p>Scissors, serrated, tips curved to the left, with carbide inserts, PEEK insulation of the distal shaft</p>	5 mm / 310 mm	 <p>PM710R</p>	 <p>PM973R</p>	 <p>P0958R</p>	 <p>PM975R</p> <p>Ø 5/10 mm</p>

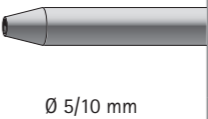
AdTec® MONOPOLAR

SCISSORS









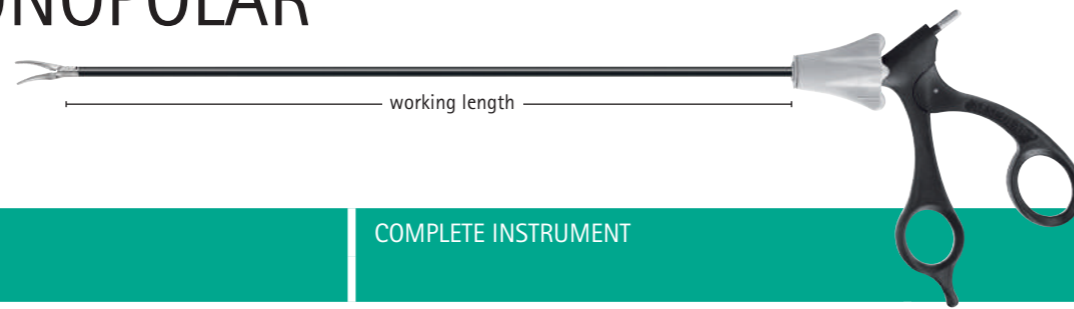





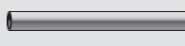



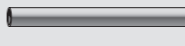



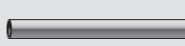

		COMPLETE INSTRUMENT	SINGLE PARTS			INDIVIDUAL COMPONENTS	
			Jaw insert	Insulated outer tube	Handle		
	PO001R	Hook scissors, blunt 5 mm / 310 mm				 Ø 5/10 mm	
	PO025R	Hook scissors, blunt 5 mm / 420 mm					
	PO002R	Peritoneal scissors, serrated 5 mm / 310 mm				 Ø 5/10 mm	
	PO006R	Peritoneal scissors with hook, serrated 5 mm / 310 mm				 Ø 5/10 mm	
		Micro-dissecting scissors, tips curved to the left 5 mm / 220 mm				 Ø 5/10 mm	
	PO003R	Micro-dissecting scissors, tips curved to the left 5 mm / 310 mm				 Ø 5/10 mm	
	PO014R	POTTS de MARTELL Mod. SAID DUROTIP Endo vessel scissors 10 mm / 310 mm					
		Instrument with protruding jaw parts					

AdTec® MONOPOLAR

DISSECTING FORCEPS

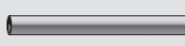

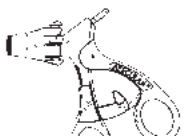
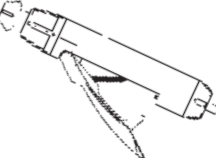
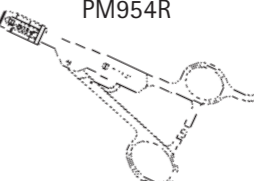
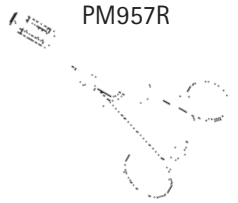







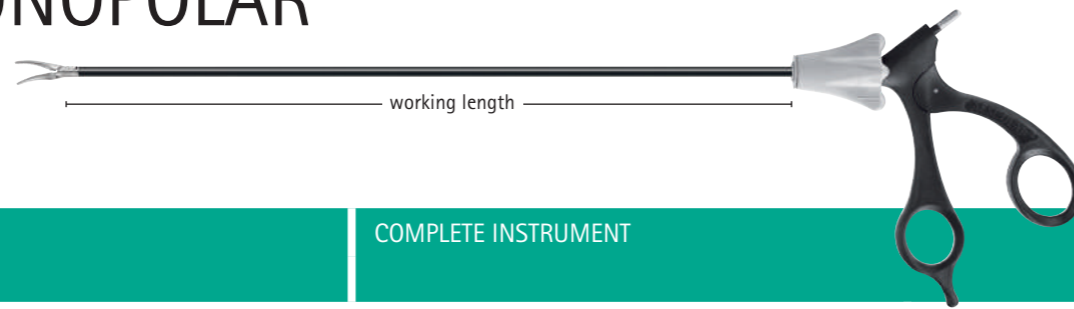







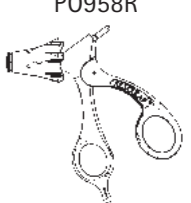

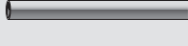

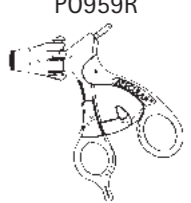





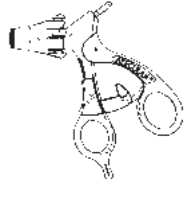

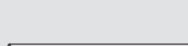

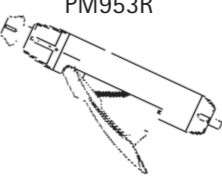

	COMPLETE INSTRUMENT	SINGLE PARTS			INDIVIDUAL COMPONENTS
		Jaw insert	Insulated outer tube	Handle	
	MARYLAND Fixation and dissecting forceps, curved 5 mm / 220 mm	P0632R	PM970R	P0958R	PM971R Ø 5/10 mm   
PO102R	MARYLAND Fixation and dissecting forceps, curved 5 mm / 310 mm	P0608R	PM973R	P0958R	PM975R Ø 5/10 mm   
	MARYLAND Fixation and dissecting forceps, curved 5 mm / 420 mm	P0752R	PM981R	P0958R	  
	MARYLAND Fixation and dissecting forceps, insulation of the distal shaft 5 mm / 310 mm Instrument with protruding jaw parts	PM699R	PM973R	P0958R	PM975R Ø 5/10 mm   
	MARYLAND Fixation and dissecting forceps, curved with cross teething 5 mm / 310 mm	P0717R	PM973R	P0958R	  
	MARYLAND Fixation and dissecting forceps, curved with cross teething 5 mm / 420 mm	P0718R	PM981R	P0958R	  
					 P0958R  P0959R  PM953R  PM954R  PM957R

DISSECTING FORCEPS

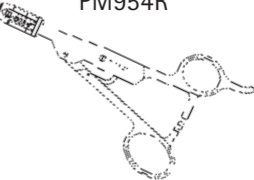
AdTec® MONOPOLAR

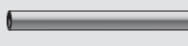
DISSECTING FORCEPS



		COMPLETE INSTRUMENT	SINGLE PARTS			INDIVIDUAL COMPONENTS		
			Jaw insert	Insulated outer tube	Handle			
	PO195R	CROCE/OLMI Fixation and dissection forceps, curved, jaw parts fenestrated	5 mm / 310 mm					
20 mm	1/1					Ø 5/10 mm		
	PO100R	Forceps with atraumatic teeth	5 mm / 310 mm					
26 mm	1/1					Ø 5/10 mm		
		Fixation and dissecting forceps, slim	5 mm / 310 mm					
19 mm	1/1	Instrument with protruding jaw parts				Ø 5/10 mm		
		Fixation and dissecting forceps, slim	5 mm / 310 mm					
25 mm	1/1					Ø 5/10 mm		
	PO187R	PSALMON Precise-dissector, 90°	5 mm / 310 mm					
16 mm	1/1					Ø 5/10 mm		
	PO231R	MIXTER Dissecting clamp, 90°	5 mm / 310 mm					
27 mm	1/1					Ø 5/10 mm		

AdTec® MONOPOLAR

DISSECTING FORCEPS

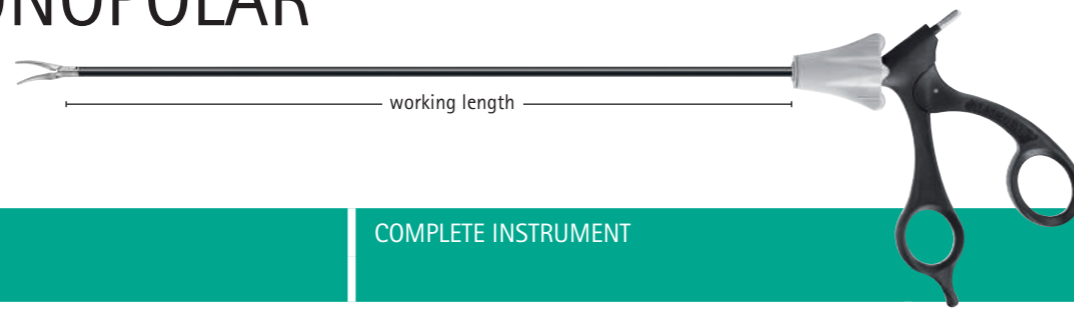









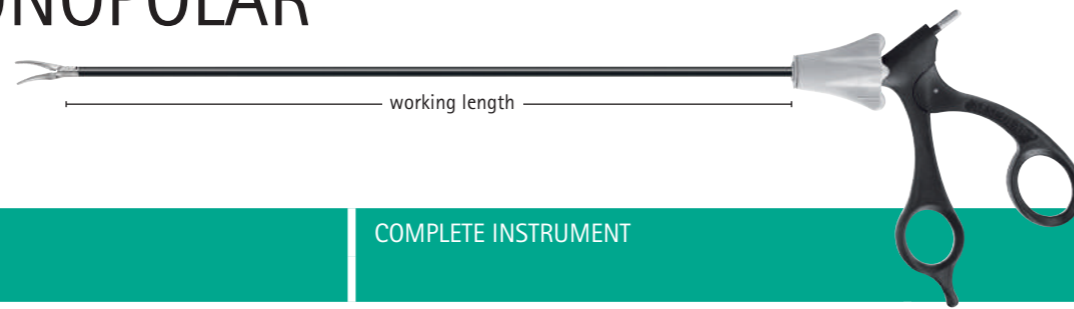







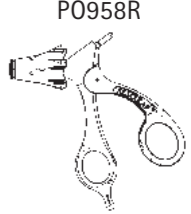





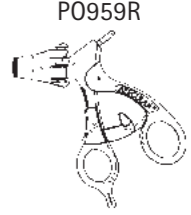

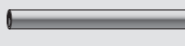

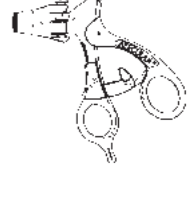



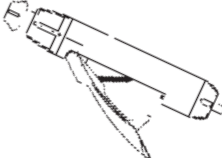

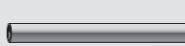

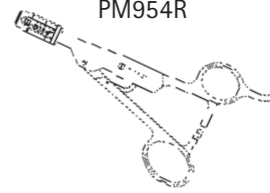



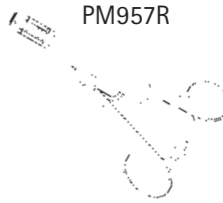

	COMPLETE INSTRUMENT		SINGLE PARTS			INDIVIDUAL COMPONENTS	
	Image	Description	Jaw insert	Insulated outer tube	Handle	Shaft	Diagram
	PO103R OVERHOLT Dissecting clamp, 90°	10 mm / 310 mm	 PO606R	 PM975R	 PO958R	 PM973R Ø 5 mm	 PO958R
	PO103R OVERHOLT Dissecting clamp, 90°, PEEK insulation of the distal shaft	10 mm / 370 mm	 PM701R	 PM978R	 PO958R	 PM976R Ø 5 mm	 PO959R
	PO219R OVERHOLT Dissecting forceps with fine tip, 90°	10 mm / 370 mm	 PO772R	 PM978R	 PO958R	 PM976R Ø 5 mm	 PO959R
	PO141R OVERHOLT Dissecting clamp, 60°	10 mm / 310 mm	 PO661R	 PM975R	 PO958R	 PM973R Ø 5 mm	 PM953R
	PO141R OVERHOLT Dissecting clamp, 60°, PEEK insulation of the distal shaft	10 mm / 310 mm	 PM700R	 PM975R	 PO958R	 PM973R Ø 5 mm	 PM954R
	PO220R OVERHOLT Dissecting forceps with fine tip, 60°	10 mm / 370 mm	 PO773R	 PM978R	 PO958R	 PM976R Ø 5 mm	 PO959R
	PO218R CRILE Fixation and dissecting forceps, curved	5 mm / 310 mm	 PO771R	 PM973R	 PO958R	 PM975R Ø 5/10 mm	 PM957R
	PO213R CRILE Fixation and dissecting forceps, curved	5 mm / 370 mm	 PO766R	 PM976R	 PO958R	 PM978R Ø 5/10 mm	

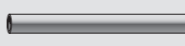
DISSECTING FORCEPS

AdTec® MONOPOLAR

DISSECTING FORCEPS











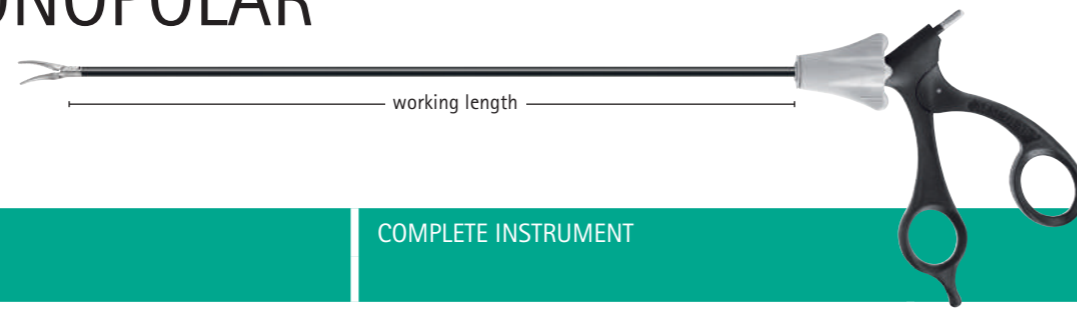





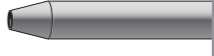



		COMPLETE INSTRUMENT	SINGLE PARTS			INDIVIDUAL COMPONENTS
			Jaw insert	Insulated outer tube	Handle	
	PO147R 1/1	5 mm / 310 mm Fixation forceps with jaw groove, slim tapering jaw tip				 Ø 5/10 mm 
	PO101R 1/1	5 mm / 220 mm Atraumatic fixation and dissecting forceps				 Ø 5/10 mm 
	PO199R 1/1	5 mm / 310 mm Atraumatic fixation and dissecting forceps				 Ø 5/10 mm 
	PO214R 1/1	5 mm / 420 mm Atraumatic fixation and dissecting forceps				
	PO151R 1/1	5 mm / 370 mm Atraumatic universal forceps				 Ø 5/10 mm 
	PO190R 1/1	5 mm / 310 mm Delicate dissecting forceps				 Ø 5/10 mm 
	PO203R 1/1	5 mm / 310 mm Fixation and dissecting forceps with jaw groove				 Ø 5/10 mm
	PO203R 1/1	5 mm / 420 mm Fixation and dissecting forceps with jaw groove				 Ø 5/10 mm

DISSECTING FORCEPS

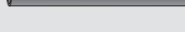
AdTec® MONOPOLAR

GRASPING FORCEPS

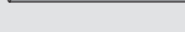

	COMPLETE INSTRUMENT	SINGLE PARTS			INDIVIDUAL COMPONENTS
		Jaw insert	Insulated outer tube	Handle	
 <p>PO109R Crocodile forceps, extra-long jaws 1/1</p>	5 mm / 310 mm	 <p>PO615R</p>	 <p>PM973R</p>	 <p>P0959R</p>	 <p>PM975R Ø 5/10 mm</p>
 <p>PO127R Universal fixation forceps with jaw grooves 1/1</p>	5 mm / 310 mm	 <p>PO644R</p>	 <p>PM973R</p>	 <p>P0959R</p>	 <p>PM975R Ø 5/10 mm</p>
 <p>PO221R Universal grasping forceps with reservoir in the jaws 1/1</p>	5 mm / 310 mm	 <p>PO774R</p>	 <p>PM973R</p>	 <p>P0959R</p>	 <p>PM975R Ø 5/10 mm</p>
 <p>PO230R Universal grasping forceps with reservoir in the jaws 1/1</p>	5 mm / 420 mm	 <p>PO783R</p>	 <p>PM981R</p>	 <p>P0959R</p>	

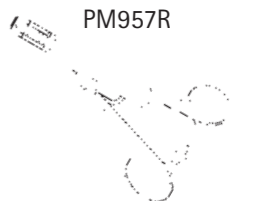
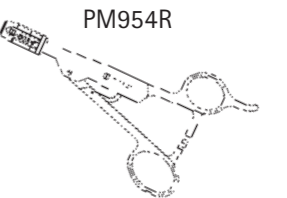
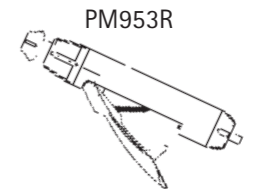
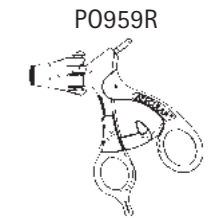
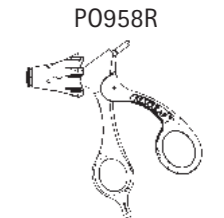







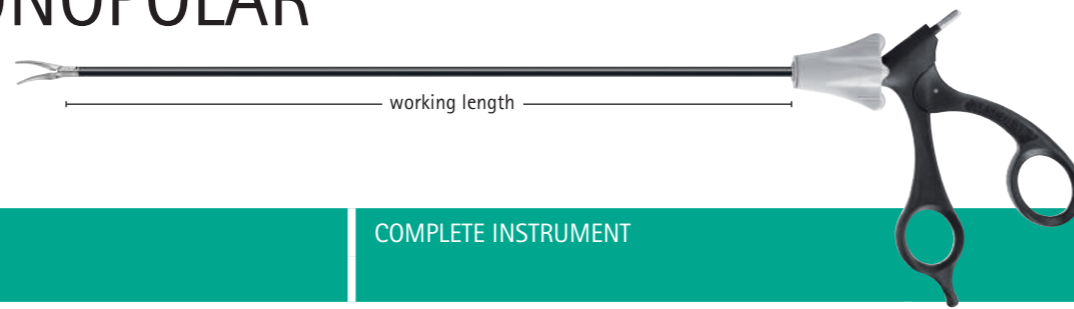

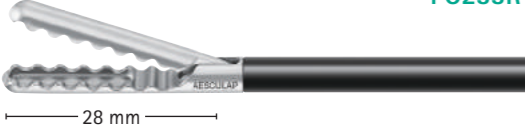



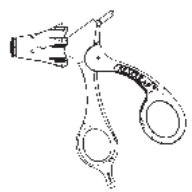

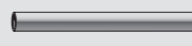

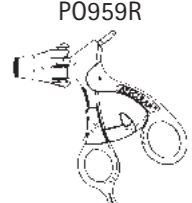

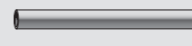

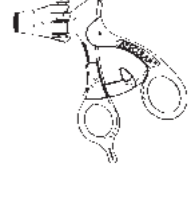



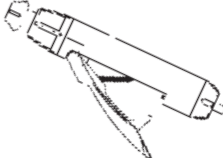

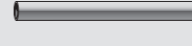

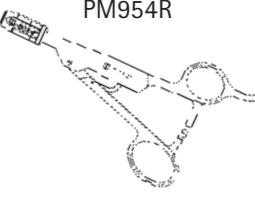

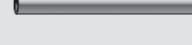

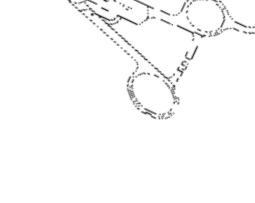

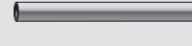
GRASPING FORCEPS

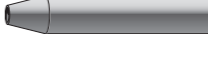
AdTec® MONOPOLAR

GRASPING FORCEPS

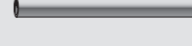







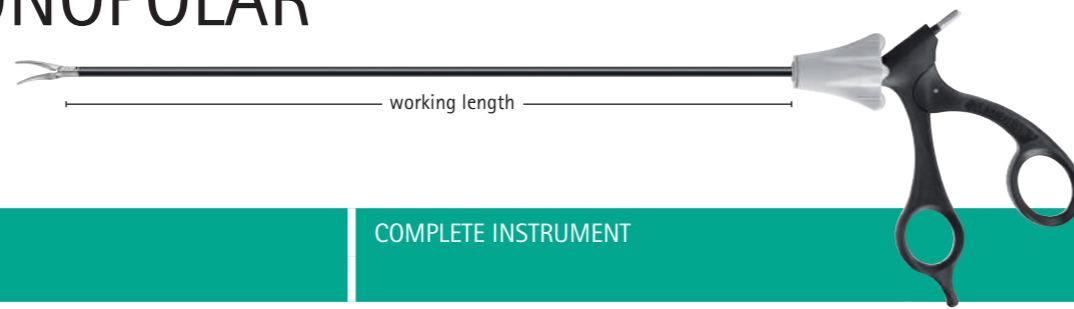





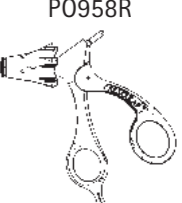

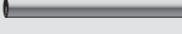

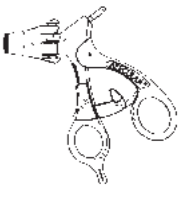

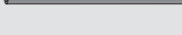

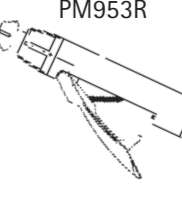

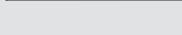

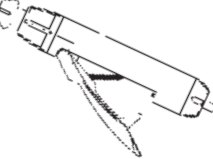

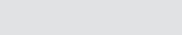

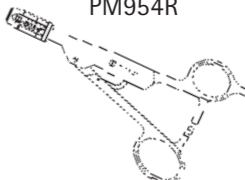

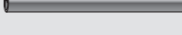

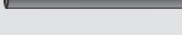

		COMPLETE INSTRUMENT	SINGLE PARTS			INDIVIDUAL COMPONENTS
			Jaw insert	Insulated outer tube	Handle	
	PO233R 1/1	Atraumatic universal forceps with grooves 5 mm / 310 mm				 Ø 5/10 mm 
	PO234R 1/1	Atraumatic universal forceps with grooves 5 mm / 420 mm				 Ø 5/10 mm 
	PO235R 1/1	Atraumatic universal forceps with grooves 5 mm / 310 mm				 Ø 5/10 mm 
	PO236R 1/1	Atraumatic universal forceps with grooves 5 mm / 420 mm				
	PO216R 1/1	Atraumatic grasping forceps, jaw part fenestrated 5 mm / 310 mm				 Ø 5/10 mm 
	PO217R 1/1	Atraumatic grasping forceps, jaw part fenestrated 5 mm / 420 mm				
	PO128R 1/1	Atraumatic universal grasping forceps, jaw part fenestrated 5 mm / 310 mm				 Ø 5/10 mm 
	PO229R 1/1	Atraumatic universal grasping forceps, jaw part fenestrated 5 mm / 420 mm				 Ø 5/10 mm

AdTec® MONOPOLAR

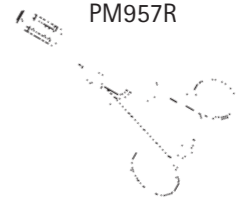
GRASPING FORCEPS

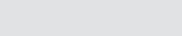









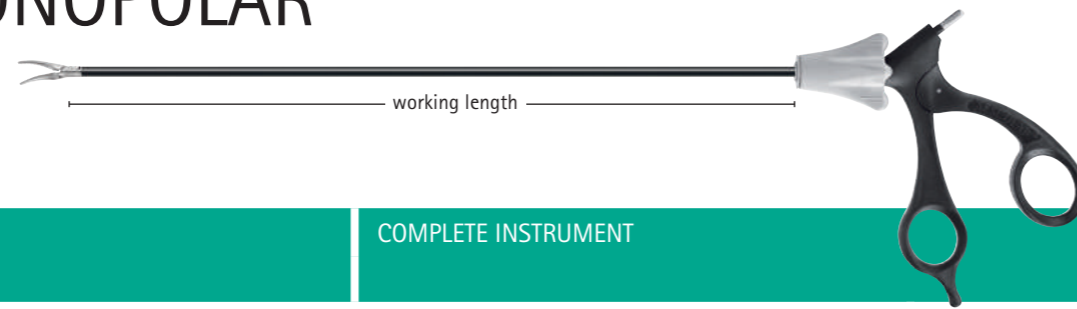





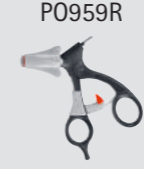
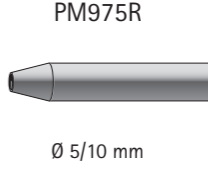
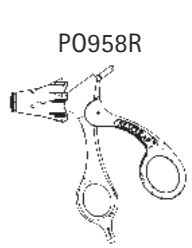



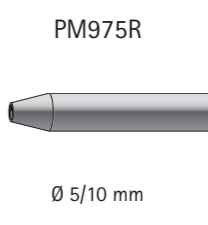
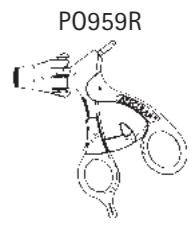
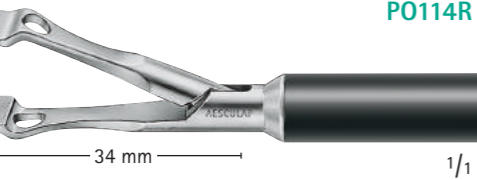

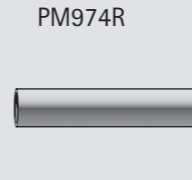

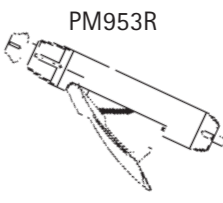



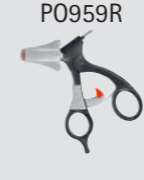



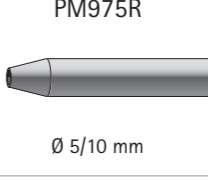
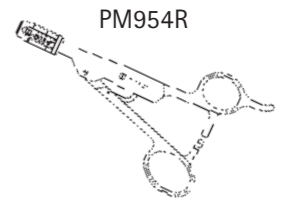

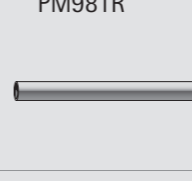
	COMPLETE INSTRUMENT	SINGLE PARTS			INDIVIDUAL COMPONENTS
		Jaw insert	Insulated outer tube	Handle	
 <p>PO191R Universal fixation and dissecting forceps, jaw part fenestrated</p> <p>30 mm</p> <p>1/1</p>	5 mm / 310 mm	 <p>PO736R</p>	 <p>PM973R</p>	 <p>PO959R</p>	 <p>PM975R</p> <p>Ø 5/10 mm</p>  <p>PO958R</p>
 <p>PO185R CROCE/OLMI Atraumatic grasping forceps</p> <p>30 mm</p> <p>1/1</p>	5 mm / 310 mm	 <p>PO728R</p>	 <p>PM973R</p>	 <p>PO959R</p>	 <p>PM975R</p> <p>Ø 5/10 mm</p>  <p>PO959R</p>
 <p>PO232R CROCE/OLMI Atraumatic grasping forceps, jaw part fenestrated</p> <p>30 mm</p> <p>1/1</p>	5 mm / 310 mm	 <p>PO785R</p>	 <p>PM973R</p>	 <p>PO959R</p>	 <p>PM975R</p> <p>Ø 5/10 mm</p>  <p>PO959R</p>
 <p>PO222R Short universal fixation and dissecting forceps, jaw part fenestrated</p> <p>19 mm</p> <p>1/1</p>	5 mm / 310 mm	 <p>PO775R</p>	 <p>PM973R</p>	 <p>PO959R</p>	 <p>PM975R</p> <p>Ø 5/10 mm</p>  <p>PM953R</p>
 <p>PO223R Short universal fixation and dissecting forceps, jaw part fenestrated</p> <p>19 mm</p> <p>1/1</p>	5 mm / 420 mm	 <p>PO776R</p>	 <p>PM981R</p>	 <p>PO959R</p>	 <p>PM954R</p>
 <p>PO112R DORSEY Intestinal grasping forceps</p> <p>35 mm</p> <p>1/1</p>	5 mm / 310 mm	 <p>PO618R</p>	 <p>PM973R</p>	 <p>PO959R</p>	 <p>PM975R</p> <p>Ø 5/10 mm</p>  <p>PO112R</p>
 <p>PO112R DORSEY Intestinal grasping forceps</p> <p>35 mm</p> <p>1/1</p>	5 mm / 370 mm	 <p>PM618R</p>	 <p>PM976R</p>	 <p>PO959R</p>	 <p>PM978R</p> <p>Ø 5/10 mm</p>  <p>PO112R</p>
 <p>PO204R DORSEY Intestinal grasping forceps</p> <p>35 mm</p> <p>1/1</p>	5 mm / 420 mm	 <p>PO755R</p>	 <p>PM981R</p>	 <p>PO959R</p>	 <p>PM957R</p>

GRASPING FORCEPS

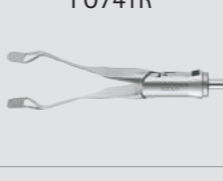
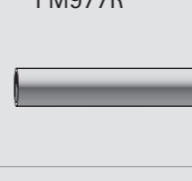
AdTec® MONOPOLAR

GRASPING FORCEPS

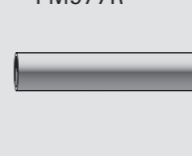









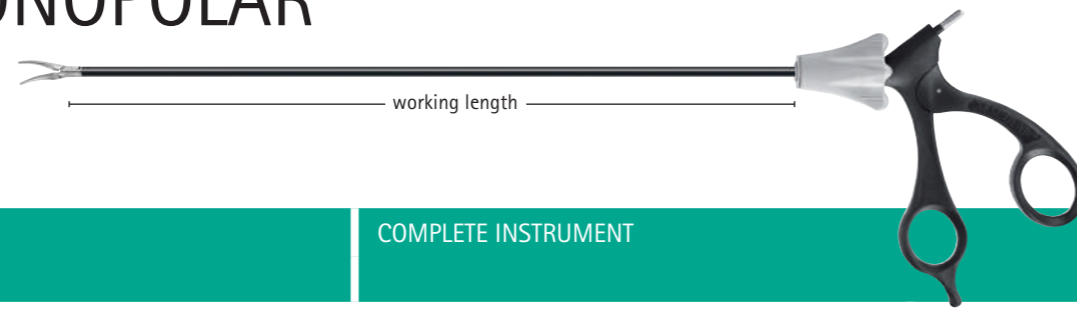



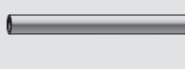

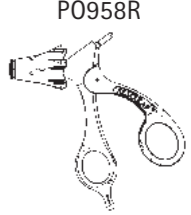

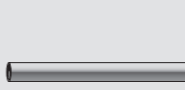

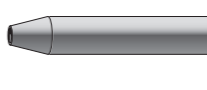
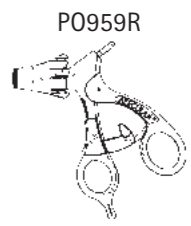

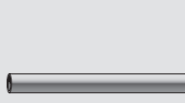

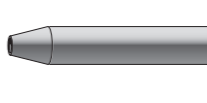
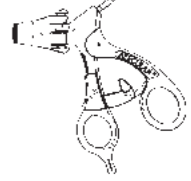

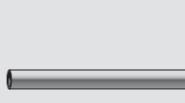

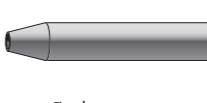
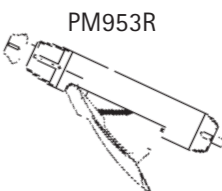

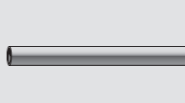

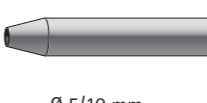
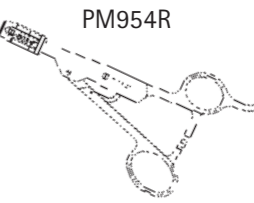
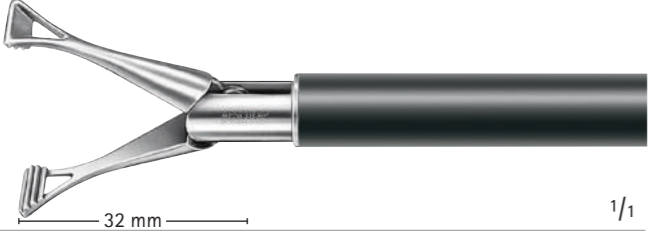

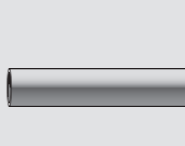
		COMPLETE INSTRUMENT	SINGLE PARTS			INDIVIDUAL COMPONENTS	
			Jaw insert	Insulated outer tube	Handle		
	PO113R 1/1	BABCOCK Tissue-grasping forceps 5 mm / 310 mm				 PM975R Ø 5/10 mm	
	PO114R 1/1	BABCOCK Tissue-grasping forceps 5 mm / 310 mm For use with flexible 13 mm trocars only				 PM975R Ø 5/10 mm	
	PO205R 1/1	BABCOCK Tissue-grasping forceps 10 mm / 310 mm					
	PO212R 1/1	BABCOCK Tissue-grasping forceps 10 mm / 420 mm					
	PO209R 1/1	BABCOCK Tissue-grasping forceps 5 mm / 310 mm				 PM975R Ø 5/10 mm	
	PO196R 1/1	BABCOCK Tissue-grasping forceps 5 mm / 420 mm					
	PO197R 1/1	BABCOCK Tissue-grasping forceps 10 mm / 370 mm					
	PO197R 3/4	MEYER Tissue grasping and manipulation forceps, jaw length 90 mm 10 mm / 370 mm					

GRASPING FORCEPS

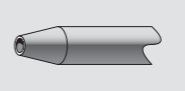
AdTec® MONOPOLAR

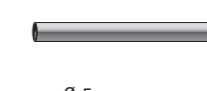
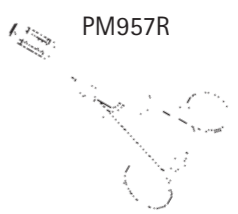
GRASPING FORCEPS

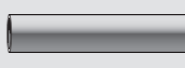







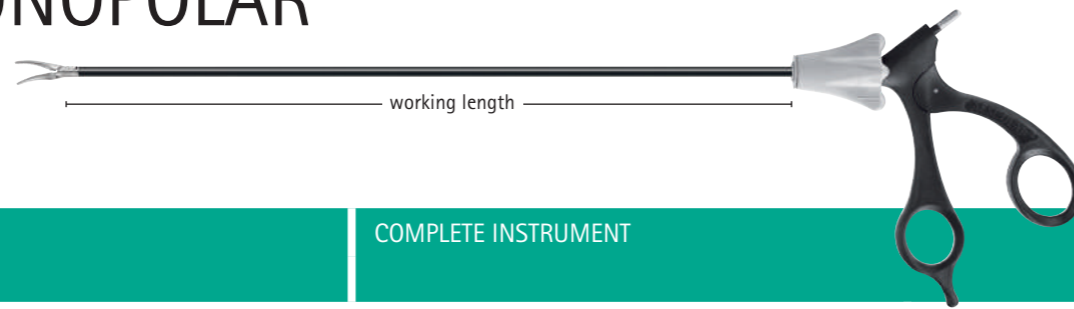





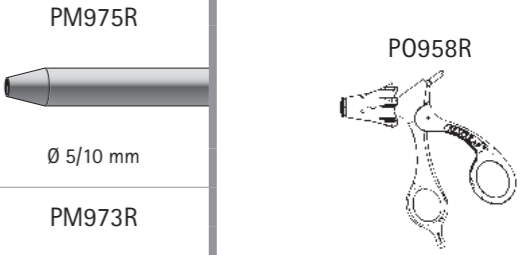



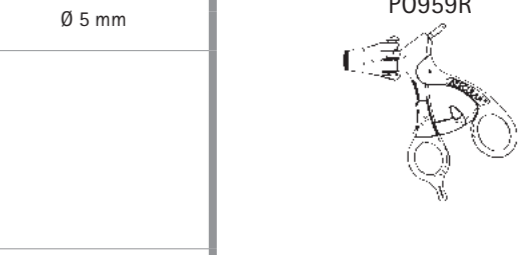
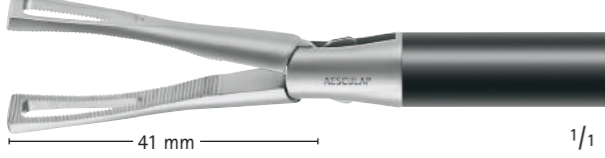



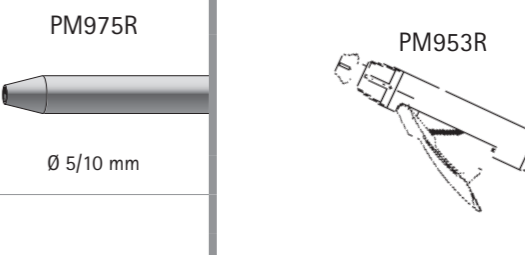



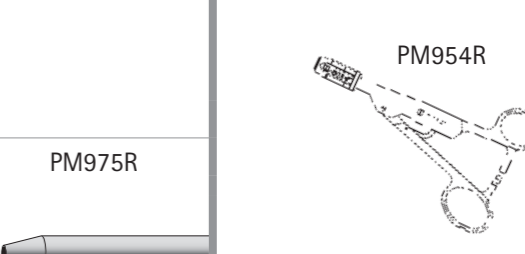



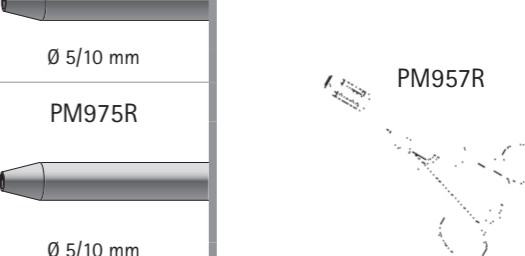

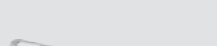
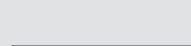

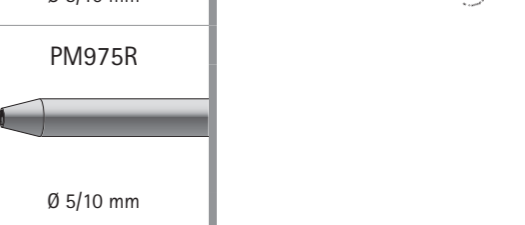
	COMPLETE INSTRUMENT	SINGLE PARTS			INDIVIDUAL COMPONENTS	
		Jaw insert	Insulated outer tube	Handle		
 <p>PO104R 35 mm 1/1</p>	<p>ALLIS Atraumatic tissue grasping forceps</p> <p>Instrument with protruding jaw parts</p>	5 mm / 310 mm	<p>PO610R</p> 	<p>PM973R</p> 	<p>PO958R</p> 	<p>PM975R</p>  <p>Ø 5/10 mm</p> 
 <p>30 mm 1/1</p>	<p>ALLIS Atraumatic grasping forceps</p> <p>For use with flexible 13 mm trocars only</p>	5 mm / 310 mm	<p>PM670R</p> 	<p>PM973R</p> 	<p>PO959R</p> 	<p>PM975R</p>  <p>Ø 5/10 mm</p> 
 <p>36 mm 1/1</p>	<p>LINDER Endo lung grasping forceps</p> <p>For use with flexible 13 mm trocars only</p>	5 mm / 220 mm	<p>PM696R</p> 	<p>PM970R</p> 	<p>PO958R</p> 	<p>PM971R</p>  <p>Ø 5/10 mm</p> 
 <p>36 mm 1/1</p>	<p>LINDER Endo lung grasping forceps</p> <p>For use with flexible 13 mm trocars only</p>	5 mm / 310 mm	<p>PM687R</p> 	<p>PM973R</p> 	<p>PO958R</p> 	<p>PM975R</p>  <p>Ø 5/10 mm</p> 
 <p>29 mm 1/1</p>	<p>DUVAL Atraumatic endo parenchyma fixation forceps</p> <p>Instrument with protruding jaw parts</p>	5 mm / 310 mm	<p>PM609R</p> 	<p>PM973R</p> 	<p>PO959R</p> 	<p>PM975R</p>  <p>Ø 5/10 mm</p> 
 <p>32 mm 1/1</p>	<p>DUVAL Atraumatic endo parenchyma fixation forceps</p> <p>Instrument with protruding jaw parts</p>	10 mm / 370 mm	<p>PM612R</p> 	<p>PM977R</p> 	<p>PO959R</p> 	<p>PM954R</p> 
 <p>40 mm 1/1</p>	<p>KIEFER Atraumatic universal and lung forceps</p>	10 mm / 310 mm	<p>PO731R</p> 	<p>PM975R</p> 	<p>PO959R</p> 	<p>PM973R</p>  <p>Ø 5 mm</p> 
 <p>62 mm 1/1</p>	<p>PO215R Intestinal grasping forceps, jaw length 60 mm</p>	10 mm / 310 mm	<p>PO768R</p> 	<p>PM974R</p> 	<p>PO959R</p> 	

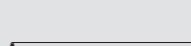
AdTec® MONOPOLAR

GRASPING FORCEPS

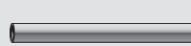









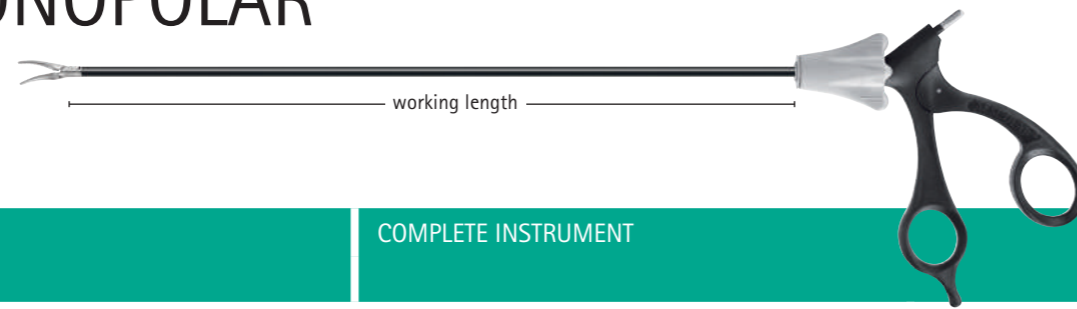







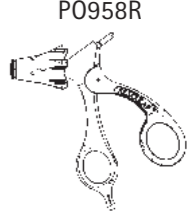



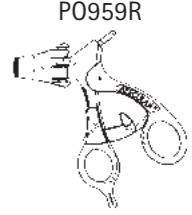

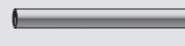

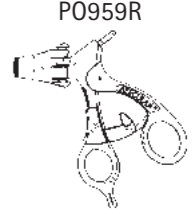

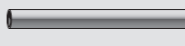
		COMPLETE INSTRUMENT	SINGLE PARTS			INDIVIDUAL COMPONENTS
			Jaw insert	Insulated outer tube	Handle	
	PO186R	CROCE/OLMI Combination fixation and dissection forceps, especially for gall bladder 28 mm 1/1				
	PO105R	HEYWOOD-SMITH Tissue- and swab forceps 34 mm 1/1				
		PENNINGTON Tissue-grasping forceps 41 mm 1/1 Instrument with protruding jaw parts				
	PO211R	Fixation forceps, medium size serration 19 mm 1/1				
	PO208R	Fixation forceps, medium size serration 19 mm 1/1				
	PO149R	Fixation forceps, jaw parts fenestrated, fine serration 18 mm 1/1				
	PO206R	Fixation forceps, jaw parts fenestrated, medium size serration 18 mm 1/1				
	PO130R	Atraumatic grasping forceps, jaw part fenestrated 29 mm 1/1				

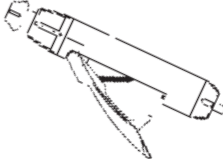
GRASPING FORCEPS

AdTec® MONOPOLAR

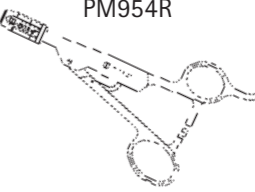
GRASPING FORCEPS

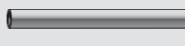

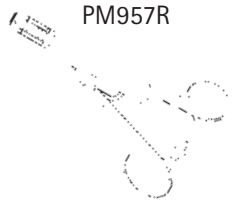



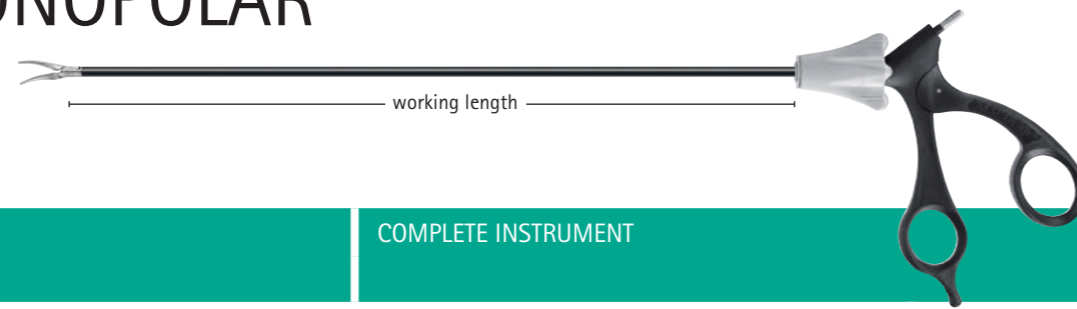

	COMPLETE INSTRUMENT	SINGLE PARTS			INDIVIDUAL COMPONENTS
		Jaw insert	Insulated outer tube	Handle	
 <p>PO129R 18 mm 1/1</p>	<p>5 mm / 310 mm</p> <p>Tube fixation and dissecting forceps</p>	<p>P0645R</p> 	<p>PM973R</p> 	<p>P0958R</p> 	<p>PM975R</p>  <p>Ø 5/10 mm</p> 
 <p>PO200R 18 mm 1/1</p>	<p>5 mm / 420 mm</p> <p>Tube fixation and dissecting forceps</p>	<p>P0748R</p> 	<p>PM981R</p> 	<p>P0958R</p> 	
 <p>PO210R 14 mm 1/1</p>	<p>5 mm / 310 mm</p> <p>Tube fixation forceps</p>	<p>P0763R</p> 	<p>PM973R</p> 	<p>P0958R</p> 	<p>PM975R</p>  <p>Ø 5/10 mm</p> 
 <p>PO207R 14 mm 1/1</p>	<p>5 mm / 420 mm</p> <p>Tube fixation forceps</p>		<p>PM981R</p> 	<p>P0958R</p> 	<p>PM953R</p> 
 <p>PO189R 46 mm 1/1</p>	<p>10 mm / 310 mm</p> <p>Endo fixation forceps, especially to grasp around the intestine</p> <p>Instrument with protruding jaw parts</p>	<p>PM681R</p> 	<p>PM974R</p> 	<p>P0959R</p> 	<p>PM954R</p> 
 <p>PO189R 53 mm 1/1</p>	<p>5 mm / 310 mm</p> <p>MASSOUD</p> <p>Delicate forceps for lateral fixation of structures and vascular grafts during dissection and anastomosis</p> <p>For use with flexible 13 mm trocars only</p>	<p>P0734R</p> 	<p>PM973R</p> 	<p>P0958R</p> 	<p>PM975R</p>  <p>Ø 5/10 mm</p> 

GRASPING FORCEPS

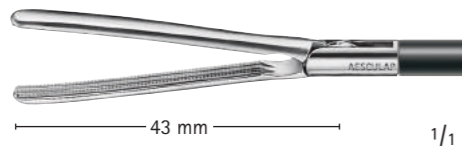
AdTec® MONOPOLAR

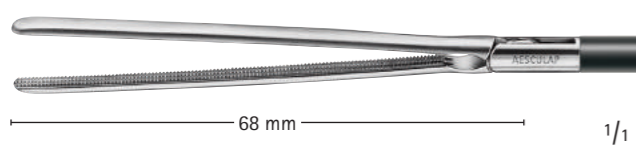
GRASPING FORCEPS



	COMPLETE INSTRUMENT		SINGLE PARTS			INDIVIDUAL COMPONENTS
	Image	Description / Dimensions	Jaw insert	Insulated outer tube	Handle	
	DE BAKEY Atraumatic clamp 5 mm / 310 mm	Instrument with protruding jaw parts	PM657R	PM973R	P0959R	PM975R Ø 5/10 mm
	DE BAKEY Atraumatic clamp 5 mm / 420 mm	Instrument with protruding jaw parts	P0657R	PM981R	P0959R	
	DE BAKEY Atraumatic clamp 5 mm / 310 mm	Instrument with protruding jaw parts	PM658R	PM973R	P0959R	PM975R Ø 5/10 mm
	DE BAKEY Atraumatic clamp 10 mm / 370 mm		PM651R	PM977R	P0959R	PM953R
	DE BAKEY Atraumatic clamp 10 mm / 220 mm		PM712R	PM992R	PM957R	PM954R
	DE BAKEY Atraumatic clamp 10 mm / 370 mm		P0624R	PM977R	P0959R	
	SIMON Renal pole clamp for local ischaemia during tumor resection 10 mm / 310 mm		P0781R	PM974R	P0959R	PM957R

GRASPING FORCEPS

AdTec® MONOPOLAR

GRASPING FORCEPS

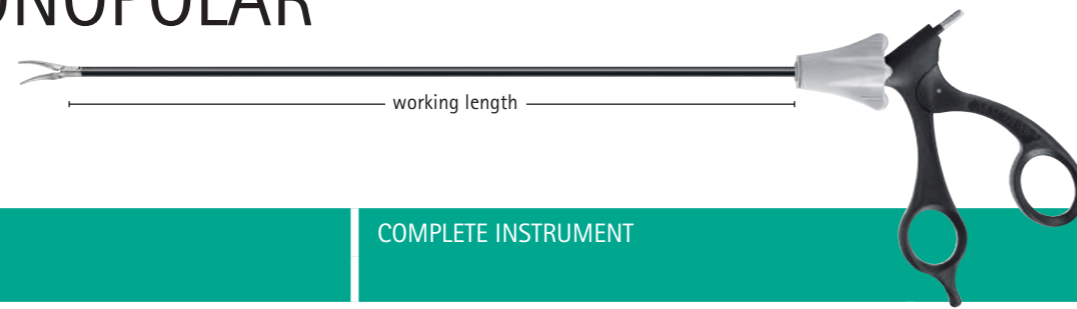









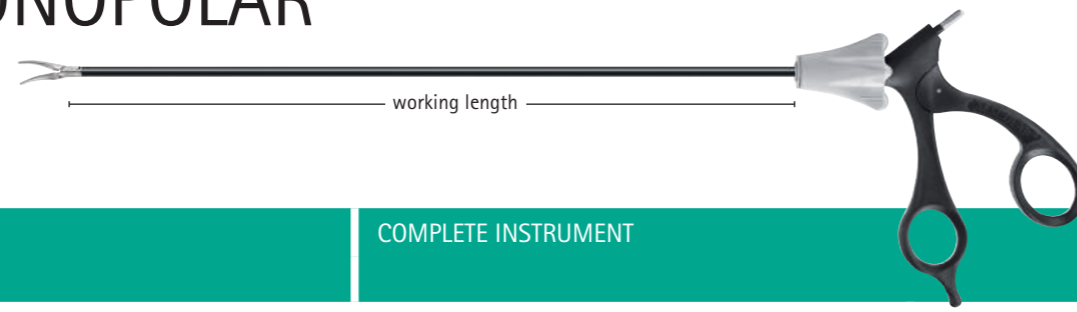







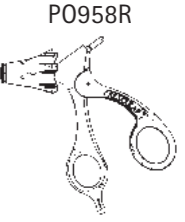

	COMPLETE INSTRUMENT		SINGLE PARTS			INDIVIDUAL COMPONENTS
	Image	Description	Jaw insert	Insulated outer tube	Handle	
<p>PM173R CRAFOORD Endo-vascular clamp 43 mm</p>	<p>5 mm / 310 mm</p> <p>For use with 10 mm trocars</p>	<p>PM713R</p>	<p>PM973R</p>	<p>PM957R</p>	<p>PM975R Ø 5/10 mm</p>	<p>P0958R</p>
<p>PM178R CRAFOORD Endo-vascular clamp 59 mm</p>	<p>5 mm / 310 mm</p> <p>For use with 10 mm trocars</p>	<p>PM719R</p>	<p>PM973R</p>	<p>PM957R</p>	<p>PM975R Ø 5/10 mm</p>	<p>P0959R</p>
<p>PO152R CRAFOORD Endo-vascular clamp 59 mm</p>	<p>5 mm / 370 mm</p> <p>For use with 10 mm trocars</p>	<p>P0684R</p>	<p>PM976R</p>	<p>P0959R</p>	<p>PM978R Ø 5/10 mm</p>	<p>P0959R</p>
<p>PM171R SATINSKY Atraumatic clamp 38 mm</p>	<p>5 mm / 310 mm</p> <p>For use with flexible 13 mm trocars only</p>	<p>PM711R</p>	<p>PM973R</p>	<p>PM957R</p>	<p>PM975R Ø 5/10 mm</p>	<p>PM953R</p>
<p>PM177R SATINSKY Atraumatic clamp 51 mm</p>	<p>5 mm / 220 mm</p> <p>For use with flexible 13 mm trocars only</p>	<p>PM690R</p>	<p>PM970R</p>	<p>PM957R</p>	<p>PM971R Ø 5/10 mm</p>	<p>PM954R</p>
<p>PM177R SATINSKY Atraumatic clamp 51 mm</p>	<p>5 mm / 310 mm</p> <p>For use with flexible 13 mm trocars only</p>	<p>PM616R</p>	<p>PM973R</p>	<p>PM957R</p>	<p>PM975R Ø 5/10 mm</p>	<p>PM957R</p>

GRASPING FORCEPS

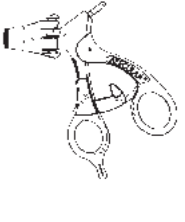
AdTec® MONOPOLAR

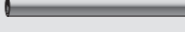
GRASPING FORCEPS

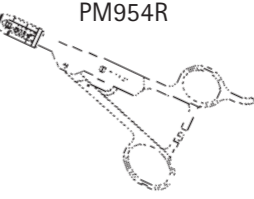







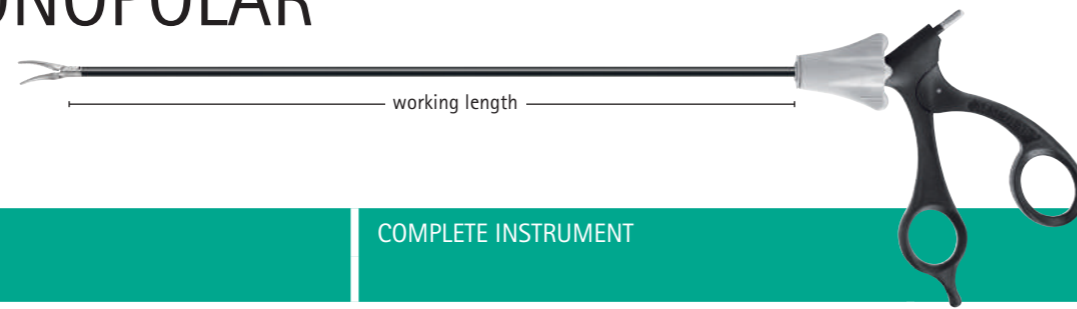

COMPLETE INSTRUMENT		SINGLE PARTS			INDIVIDUAL COMPONENTS	
		Jaw insert	Insulated outer tube	Handle		
 <p>49 mm</p> <p>1/1</p>	<p>DE BAKEY Pulmonary clamp acc. to LINDER, s-shaped</p> <p>For use with flexible 13 mm trocars only</p> <p>5 mm / 220 mm</p>	<p>PM693R</p> 	<p>PM970R</p> 	<p>PM957R</p> 	<p>PM971R</p>  <p>Ø 5/10 mm</p>	<p>P0958R</p> 
 <p>49 mm</p> <p>1/1</p>	<p>DE BAKEY Atraumatic fixation forceps acc. to LINDER, s-shaped</p> <p>For use with flexible 13 mm trocars only</p> <p>5 mm / 310 mm</p>	<p>PM689R</p> 	<p>PM973R</p> 	<p>PM957R</p> 	<p>PM975R</p>  <p>Ø 5/10 mm</p>	<p>P0959R</p> 
 <p>49 mm</p> <p>1/1</p>	<p>DE BAKEY Atraumatic fixation forceps acc. to LINDER, s-shaped</p> <p>For use with flexible 13 mm trocars only</p> <p>5 mm / 310 mm</p>	<p>PM671R</p> 	<p>PM973R</p> 	<p>PM957R</p> 	<p>PM975R</p>  <p>Ø 5/10 mm</p>	<p>PM954R</p> 
						<p>PM957R</p> 

GRASPING FORCEPS

AdTec® MONOPOLAR

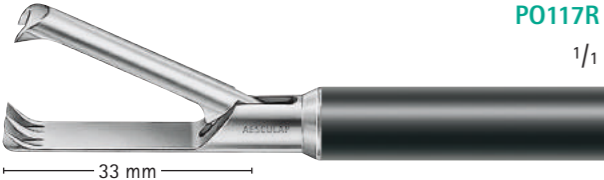
GRASPING FORCEPS











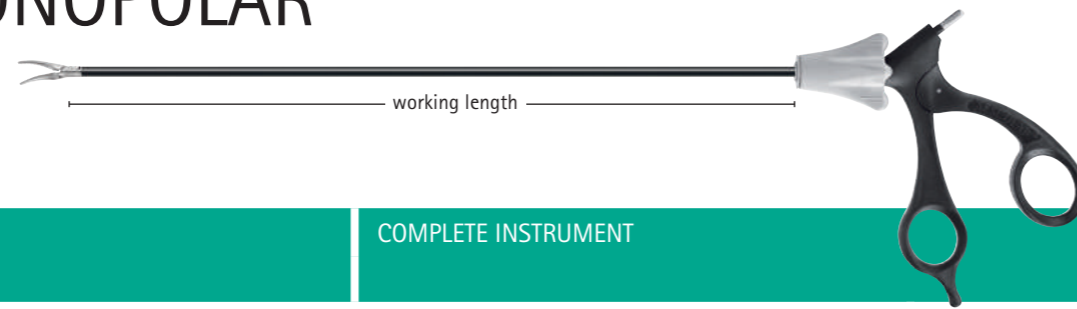







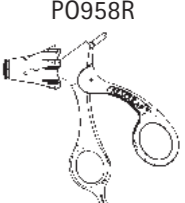





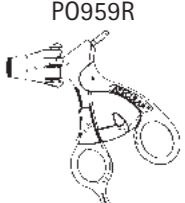

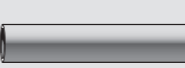
	COMPLETE INSTRUMENT	SINGLE PARTS			INDIVIDUAL COMPONENTS
		Jaw insert	Insulated outer tube	Handle	
	5 mm / 220 mm				
	Pike-mouth forceps with reservoir in the jaws 1/1	PO634R	PM970R	PO959R	PM971R Ø 5/10 mm
PO107R	5 mm / 310 mm	PO613R	PM973R	PO959R	PM975R Ø 5/10 mm
	Pike-mouth forceps with reservoir in the jaws 1/1				
	Large pike-mouth forceps extra-wide jaws 1/1	PM621R	PM974R	PO959R	
	Fixation forceps, 2 x 3 teeth 1/1	PO623R	PM974R	PO959R	PM953R
	Grasping forceps, 2 x 4 teeth 1/1	PO648R	PM973R	PO959R	PM975R Ø 5/10 mm
	Grasping forceps, 2 x 4 teeth 1/1	PO749R	PM981R	PO959R	
	Grasping forceps, 1 x 2 teeth 1/1	PM649R	PM973R	PO959R	PM975R Ø 5/10 mm
	Grasping forceps, fine teeth 1/1	PO650R	PM973R	PO959R	PM975R Ø 5/10 mm

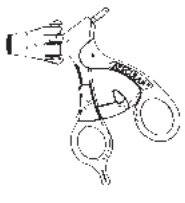
GRASPING FORCEPS

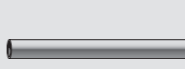
AdTec® MONOPOLAR

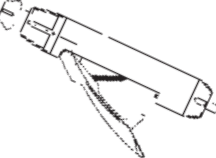
GRASPING FORCEPS

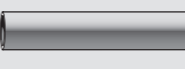

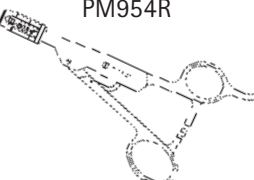
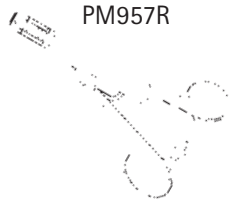







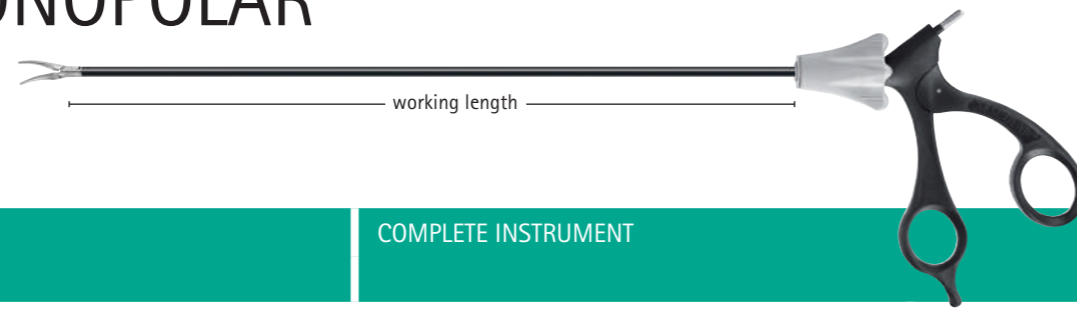

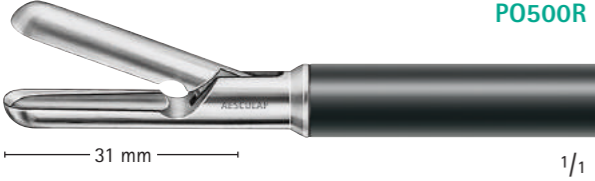



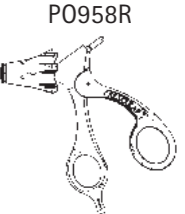





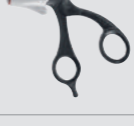
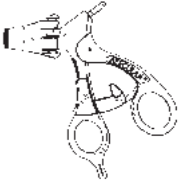

		COMPLETE INSTRUMENT	SINGLE PARTS			INDIVIDUAL COMPONENTS	
			Jaw insert	Insulated outer tube	Handle		
	PO111R 1/1	NELSON Grasping forceps, sharp 5 mm / 310 mm	 PO617R	 PM973R	 P0959R	 PM975R Ø 5/10 mm	 P0958R
	PO224R 1/1	Tenaculum Grasping forceps 5 mm / 310 mm	 PO777R	 PM973R	 P0959R	 PM975R Ø 5/10 mm	 P0959R
	PO225R 1/1	Tenaculum Grasping forceps 10 mm / 310 mm	 PO778R	 PM974R	 P0959R		 P0959R
	PO194R 1/1	Lymph node grasping forceps 5 mm / 220 mm	 PO739R	 PM970R	 P0959R	 PM971R Ø 5/10 mm	 PM953R
	PM688R 1/1	Endo lymph node fixation forceps 10 mm / 310 mm	 PM688R	 PM974R	 P0959R		 PM954R
							 PM957R

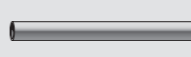
GRASPING FORCEPS

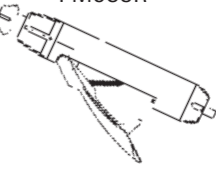
AdTec® MONOPOLAR

BIOPSY FORCEPS

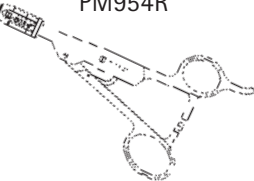





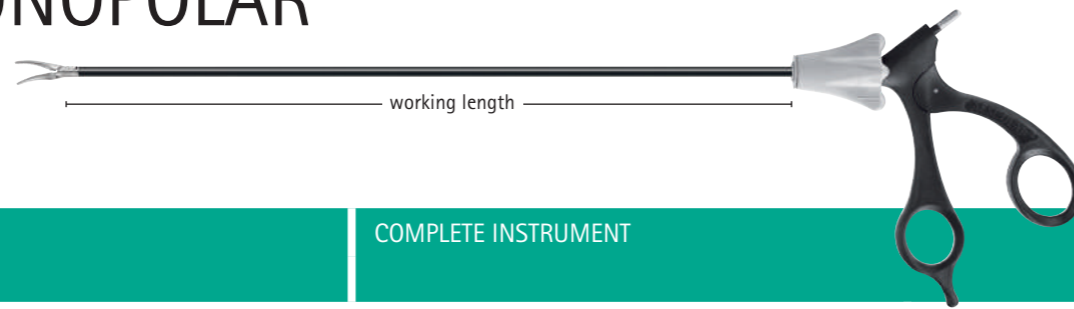

		COMPLETE INSTRUMENT	SINGLE PARTS			INDIVIDUAL COMPONENTS
			Jaw insert	Insulated outer tube	Handle	
	PO500R 1/1	Large biopsy forceps 10 mm / 310 mm				
	PO501R 1/1	Sample excision forceps 5 mm / 310 mm				 Ø 5/10 mm
	PO509R 1/1	Sample excision forceps 5 mm / 420 mm				
	PO505R 1/1	Biopsy forceps with teeth 5 mm / 310 mm				 Ø 5/10 mm
	PO511R 1/1	Biopsy forceps with teeth 5 mm / 420 mm				
						

BIOPSY FORCEPS

AdTec® MONOPOLAR

BIOPSY FORCEPS



COMPLETE INSTRUMENT		SINGLE PARTS			INDIVIDUAL COMPONENTS
		Jaw insert	Insulated outer tube	Handle	
	Biopsy forceps cutting 1/1	PM635R	PM970R	P0958R	PM971R Ø 5/10 mm
PO502R	5 mm / 220 mm				
	Biopsy forceps cutting 1/1	P0627R	PM973R	P0958R	PM975R Ø 5/10 mm
PO512R	5 mm / 310 mm				
	Biopsy forceps cutting 1/1	P0759R	PM981R	P0958R	
PO510R	5 mm / 420 mm				
	FRANGENHEIM Biopsy forceps cutting 1/1	PM653R	PM973R	P0958R	PM975R Ø 5/10 mm
PO510R	5 mm / 310 mm				
	FRANGENHEIM Biopsy forceps cutting 1/1	P0751R	PM981R	P0958R	
PO510R	5 mm / 420 mm				

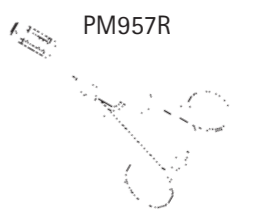
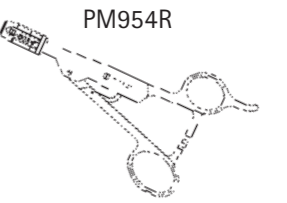
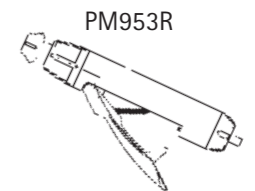
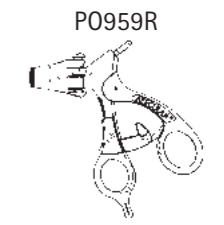
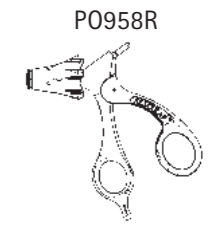







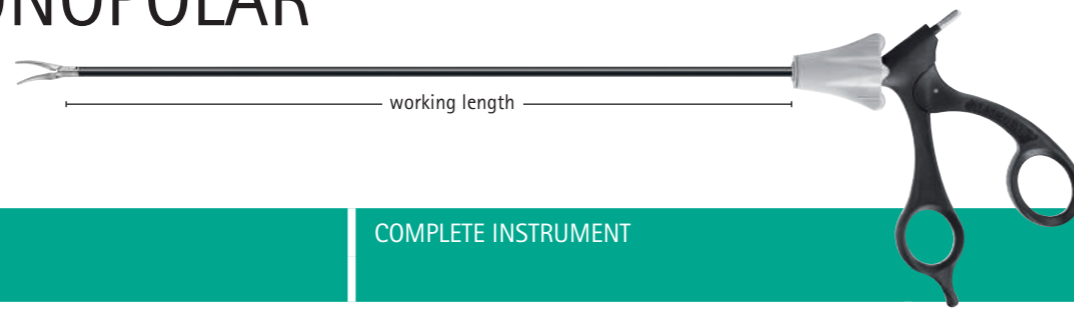





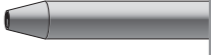

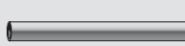
BIOPSY FORCEPS

AdTec® MONOPOLAR

NEEDLE HOLDERS



		COMPLETE INSTRUMENT	SINGLE PARTS			INDIVIDUAL COMPONENTS
			Jaw insert	Insulated outer tube	Handle	
	PO550R	5 mm / 310 mm DUROGRIP Needle holder, with tungsten carbide inserts 1/1				 Ø 5/10 mm
	PO559R	5 mm / 310 mm DUROGRIP Needle holder, with tungsten carbide inserts, curved 1/1				 Ø 5/10 mm
		5 mm / 310 mm Knot pushing forceps 1/1				 Ø 5/10 mm

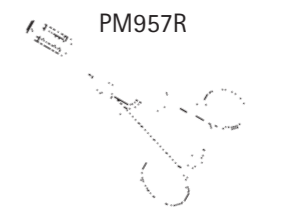
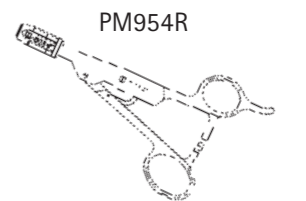
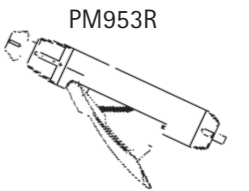
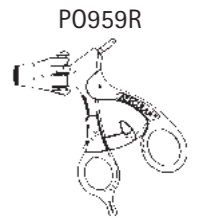
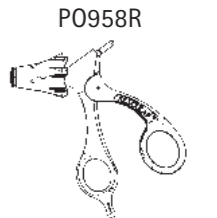

AdTec® MONOPOLAR

THORAX INSTRUMENTS

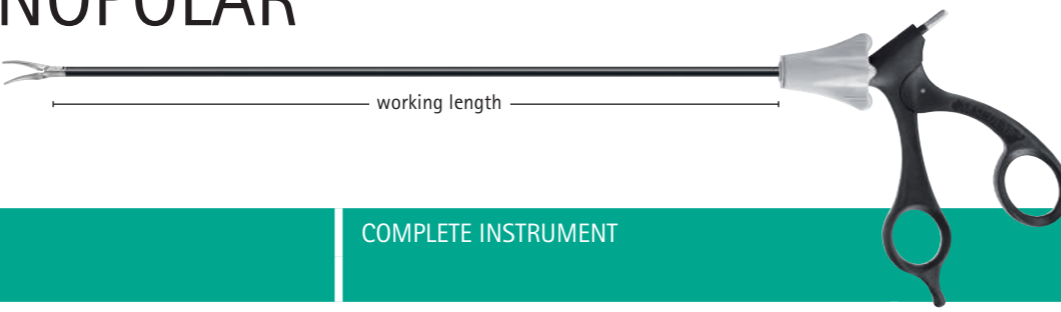

	COMPLETE INSTRUMENT	SINGLE PARTS			INDIVIDUAL COMPONENTS	
		Jaw insert	Insulated outer tube	Handle		
<p>22 mm</p> <p>1/1</p>	<p>METZENBAUM Scissors, serrated, tips curved to the left, with carbide inserts, distal shaft bent</p> <p>For use with flexible 7 or 13 mm trocars only</p>	5 mm / 310 mm	<p>PO636R + PM940R</p>	<p>PM983P</p>	<p>P0958R</p>	<p>P0958R</p>
<p>15 mm</p> <p>1/1</p>	<p>Peritoneal scissors, serrated, distal shaft bent</p> <p>For use with flexible 7 or 13 mm trocars only</p>	5 mm / 310 mm	<p>PM637R + PM940R</p>	<p>PM983P</p>	<p>P0958R</p>	<p>P0959R</p> <p>PM953R</p>
<p>21 mm</p> <p>1/1</p>	<p>MARYLAND Fixation and dissecting forceps, curved, distal shaft bent</p> <p>For use with flexible 7 or 13 mm trocars only</p>	5 mm / 310 mm	<p>PO669R + PM940R</p>	<p>PM983P</p>	<p>P0958R</p>	<p>PM954R</p>
<p>34 mm</p> <p>1/1</p>	<p>HEYWOOD-SMITH Tissue and swab forceps, distal shaft bent</p> <p>For use with flexible 13 mm trocars only</p>	5 mm / 310 mm	<p>PO641R + PM940R</p>	<p>PM983P</p>	<p>P0959R</p>	<p>PM957R</p>

AdTec® MONOPOLAR

THORAX INSTRUMENTS

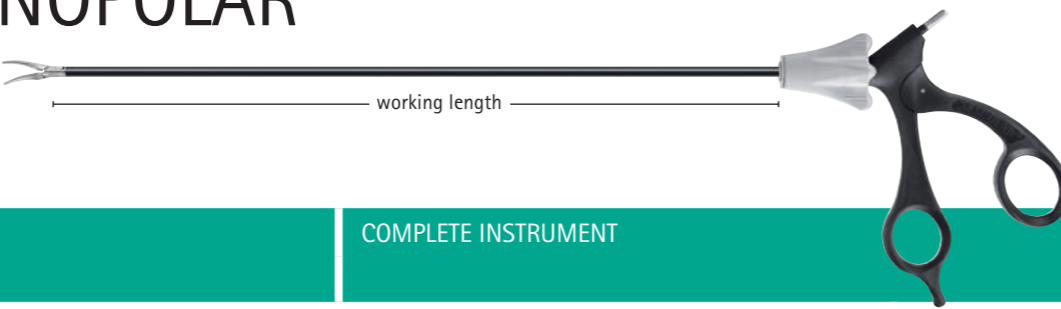

COMPLETE INSTRUMENT		SINGLE PARTS			INDIVIDUAL COMPONENTS
		Jaw insert	Insulated outer tube	Handle	
<p>17 mm</p>	<p>Pike-mouth forceps with reservoir in the jaws, distal shaft bent</p> <p>For use with flexible 7 or 13 mm trocars only</p> <p>1/1</p>	<p>5 mm / 310 mm</p> <p>PO642R + PM940R</p>	<p>PM983P</p>	<p>P0959R</p>	<p>P0958R</p>
<p>19 mm</p>	<p>NELSON Grasping forceps, sharp, distal shaft bent</p> <p>For use with flexible 7 or 13 mm trocars only</p> <p>1/1</p>	<p>5 mm / 310 mm</p> <p>PO638R + PM940R</p>	<p>PM983P</p>	<p>P0959R</p>	<p>P0959R</p>
<p>15 mm</p>	<p>Sample excision forceps, distal shaft bent</p> <p>For use with flexible 7 or 13 mm trocars only</p> <p>1/1</p>	<p>5 mm / 310 mm</p> <p>PM643R + PM940R</p>	<p>PM983P</p>	<p>P0959R</p>	<p>PM953R</p>
					<p>PM954R</p>
					<p>PM957R</p>

MONOPOLAR LAPAROSCOPIC ELECTRODES



THE MODULAR PRINCIPLE ALSO INCLUDES IMPORTANT SAFETY ASPECTS

- modular design simplifies disassembly, cleaning, maintenance and sterile preparation
- bayonet connection
- individual combinations possible
- fast exchange of individual components due to modular design
- ceramic tips
- insulation up to the working tip

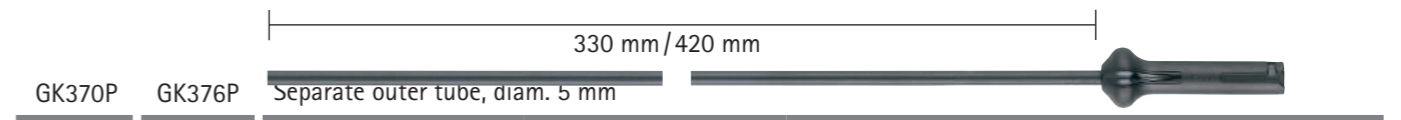
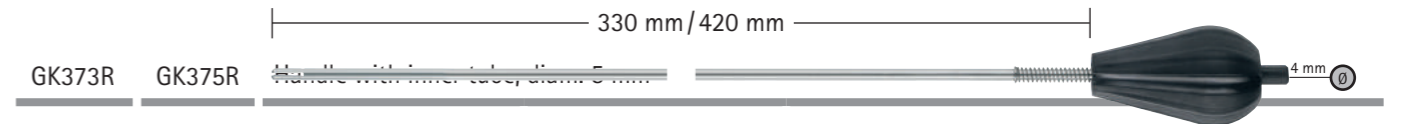
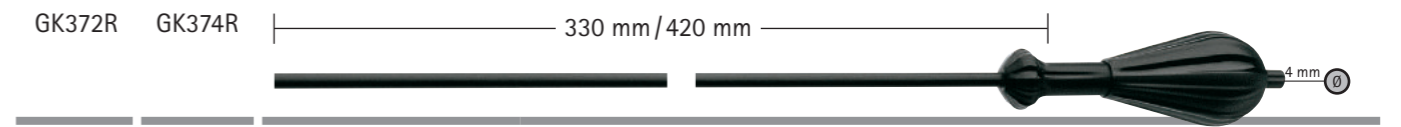

GK383R		Hook electrode, J-shaped
GK384R		Hook electrode, L-shaped
GK385R		Ball electrode
GK386R		Spatula electrode
GK393R		Hook electrode, J-shaped
GK394R		Hook electrode, J-shaped, 90° curved to the right
GK395R		Ball electrode, curved

MONOPOLAR LAPAROSCOPIC ELECTRODES



GK389R Pin electrode only (pack of 5 pcs.)
product is to be reprocessed only once (delivery unsterile)



GK373R Handle with inner tube, diam. 5 mm



GK371P Separate outer tube, diam. 5 mm



Art. no. Monopolar connecting cable 3.5 m; on the instrument side for a 4 mm contact pin



GN202 AESCULAP®, ACMI, Berchtold, Martin

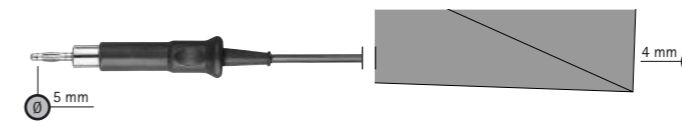

GK239 ERBE ICC / ACC, KARL STORZ

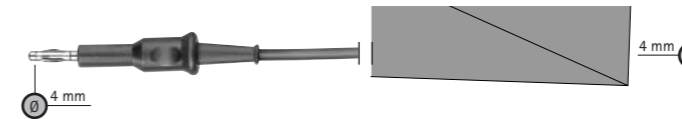

GK245 ERBE T

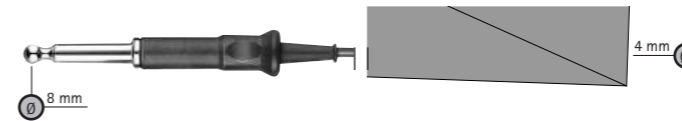





GK246 Valleylab, ACMI, Conmed, Eschmann, Erbe ICC Intern., US-Norm







GK299 the electrodes

AdTec® MONOPOLAR

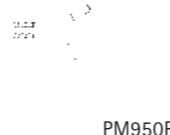

SPARE PARTS

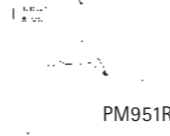
	P0950400	AESCULAP®, Wolf, Storz (Click-line), Olympus (HiQ+), including cap, package of 5 pieces	
	P0950410	Storz, old type, Package of 5 pieces	
	P0950420	Olympus (HiQ) diam. 3 mm, package of 5 pieces	

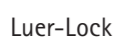
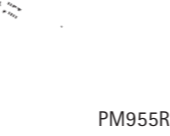
Art. no.	HF contact pin for AdTec® monopolar handle PM950R, PM951R, PM953R, PM955R only
----------	--













	PL170251	AESCULAP®, Wolf, Storz (Click-line), Olympus (HiQ+), including cap, package of 5 pieces	
	PL170256	Olympus (HiQ), diam. 3 mm, package of 5 pieces	
	PL170258	Storz, old type, package of 5 pieces	
	PL170250	Luer-Lock adapter replaces HF-pin for rinsing the instrument, package of 5 pieces for handles P0950R, P0951R, PM950R, PM951R, PM953R, PM955R	

	PM950250	Rotation knob, package of 5 pieces	
			

PM630201	220 mm	
PM600201	310 mm	
PM618201	370 mm	
PM434201	420 mm	

	PM009250	Inner tube, curved on flat, for instruments, length 310 mm
---	----------	--

	PM009251	Flexible tension rod
---	----------	----------------------

PM970R	220 mm	5/5 mm	
PM971R	220 mm	5/10 mm	
PM992R	220 mm	10/10 mm	
PM973R	310 mm	5/5 mm	
PM975R	310 mm	5/10 mm	
PM974R	310 mm	10/10 mm	
PM976R	370 mm	5/5 mm	
PM978R	370 mm	5/10 mm	
PM977R	370 mm	10/10 mm	
PM981R	420 mm	5/5 mm	
PM982R	420 mm	10/10 mm	
PM983P	310 mm	5/5 mm	

ENDO RACK

For more information see brochure number C22111.

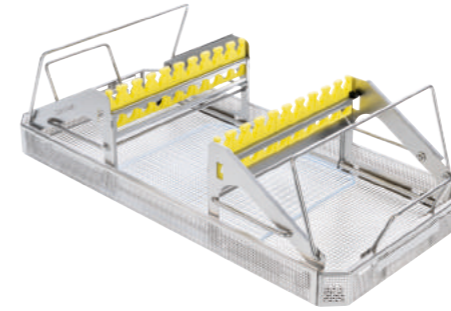
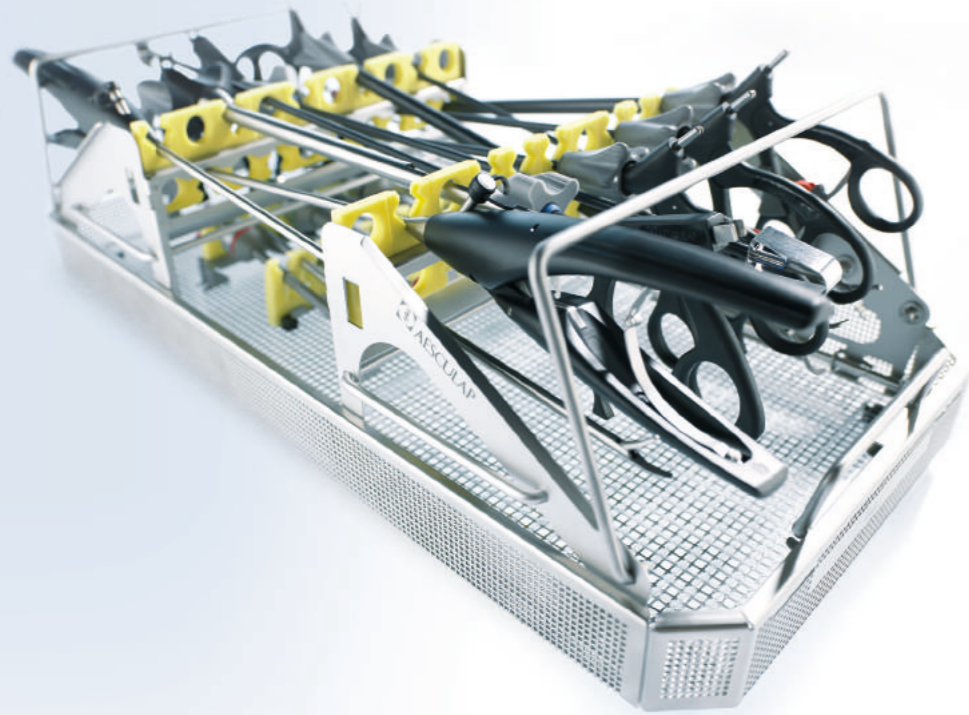

consisting of:
Storage rack, standard, perforated tray and silicon mat for instruments with shaft length up to 370 mm

PL960R Dimensions: 540 x 253 x 166 mm

JK444 + JK489

JK444 bottom and JK489 lid
External dimensions: 592 x 285 x 205 mm

- Universal silicone storage rack for instruments
- Variable instrument storage
- Fold down handles for easier instrument removal
- Optional trocar storage

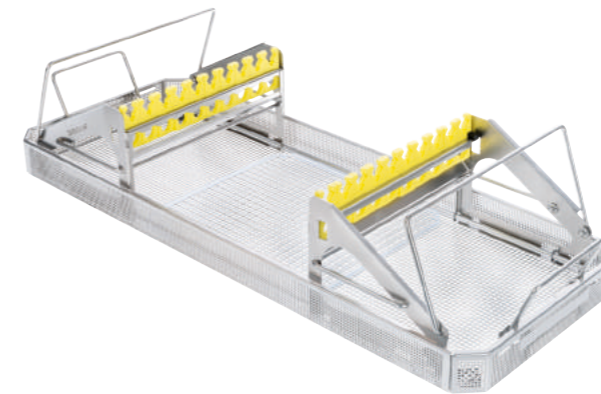
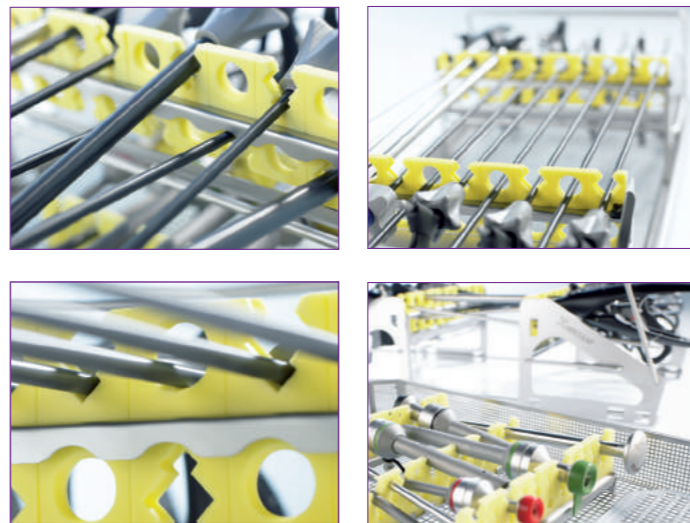

consisting of:
Storage rack, long, perforated tray and silicon mat for instruments with shaft length up to 420 mm

PL961R Dimensions: 660 x 253 x 166 mm

JN445 + JK490

JN445 bottom and JK490 lid
External dimensions: 711 x 285 x 205 mm
NB: The Endocontainer can only be sterilized in sterilizers with the appropriate chamber size (at least 720 mm working depth).

DISASSEMBLY

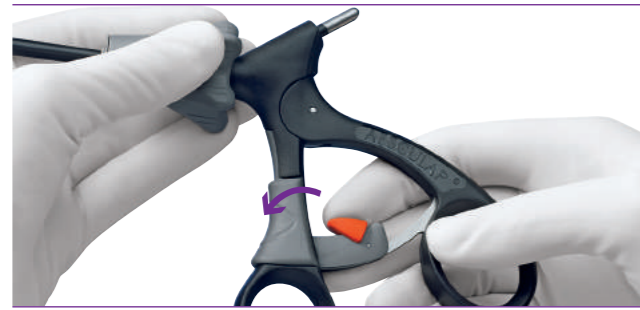

I Deactivate ratchet on ratchet handle
Flip down red toggle switch. N.B.: for P0959R only



II Disconnect shaft and handle
Pull rotation knob back until it locks in place. A red ring becomes visible.
Important: Do not hold on to the movable handle component.

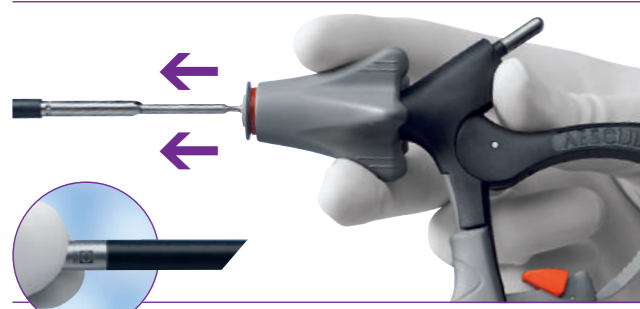

III Remove shaft from handle
Remove the shaft by pulling the instrument shaft out of the handle.

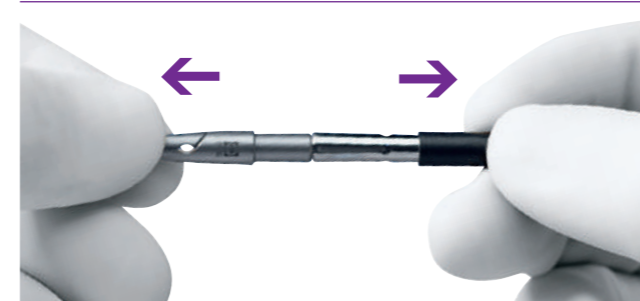

IV Disassemble shaft I
Hold the jaw insert at the tip and remove the outer insulation tube.

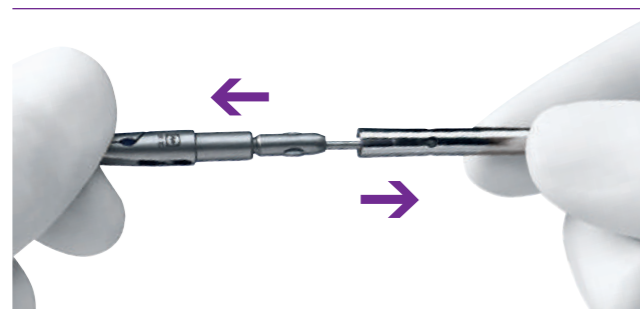

V Disassemble shaft II
Hold the jaw insert at the tip and remove the inner metal tube.

- 1 Toggle switch
- 2 Rotation knob
- 3 Movable handle component

Jaw insert

Inner metal tube

Insulated outer tube

ASSEMBLY

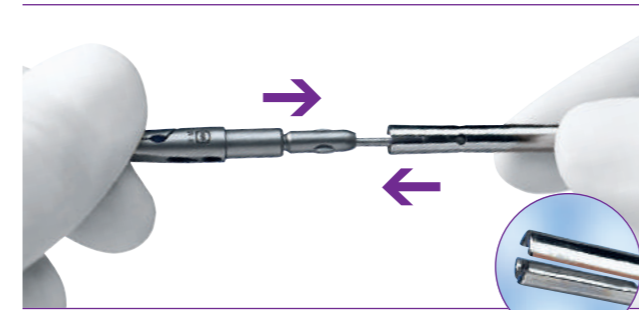

I Assemble shaft I
Slide the metal inner tube onto the jaw insert with its four spring tongues towards the working end until the tongues snap in place.

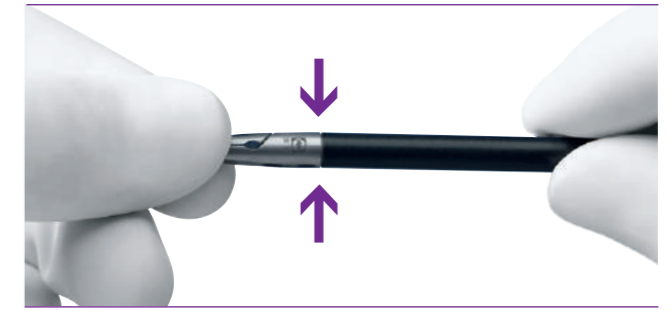

II Assemble shaft II
Slide the outer insulation tube as far as it will go over the inner metal tube.

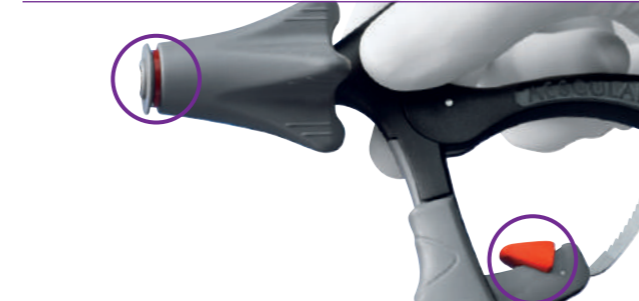

III Prepare handle
If the red ring is not visible, pull the rotation knob back. Deactivate the ratchet by flipping down the red toggle switch. N.B.: for P0959R only



IV Connect shaft and handle
Hold the shaft firmly by its tip and the handle behind the rotation knob. Push the shaft into the handle until it locks in place and the red ring disappears.
Important: Do not hold on to the movable handle component.



V Function test
Test the assembly of the instrument by opening and closing the handle to ensure the jaw is opening and closing.

Poster available: C22202

AdTec® MONOPOLAR

CURVED THORACIC INSTRUMENT



DISASSEMBLY

ASSEMBLY



I Pull back the spring mechanism indicated with an arrow as far as it will go. Hold at this position and at the same time pull out the shaft. **Note:** In the case of handle with a lock (PM954R, PM957R), open the ratchet completely.



II Pull off the insulated, flexible outer tube from the shaft.

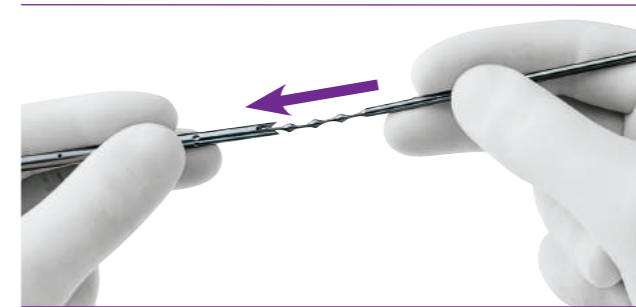

III Push the flexible tension rod into the inner tube.

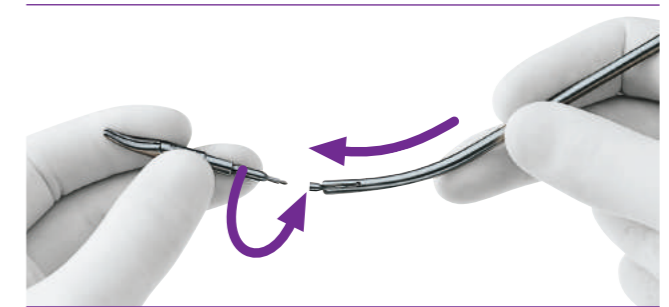

IV Push the tension rod forwards until the receptacle of the jaw part (screw thread) is clearly visible.

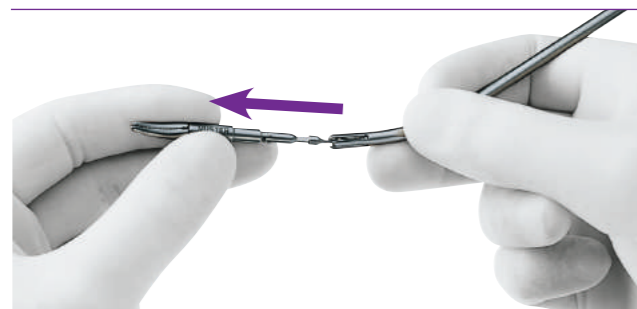

V Push flexible tension rod towards the jaw part (approx. 1 cm).

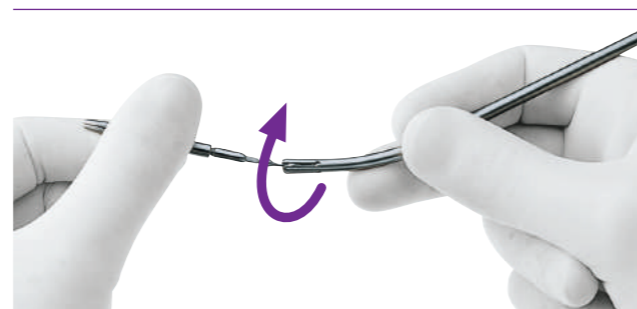

VI Unscrew the jaw part as indicated by the arrow.

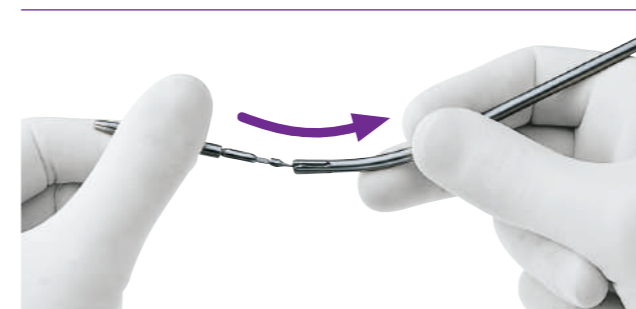

VII Screw on jaw part. Set the position of the jaw part relative to the shaft to meet the surgeon's needs. To do this, the thread connection must be slightly slackened (max. 1 turn).

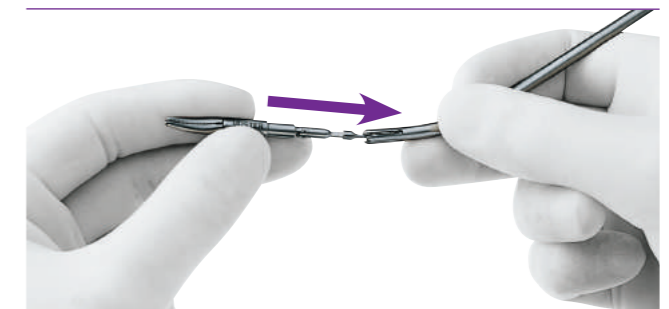

VIII Push jaw part with the flexible tension rod into the inner tube with the 4 slots.

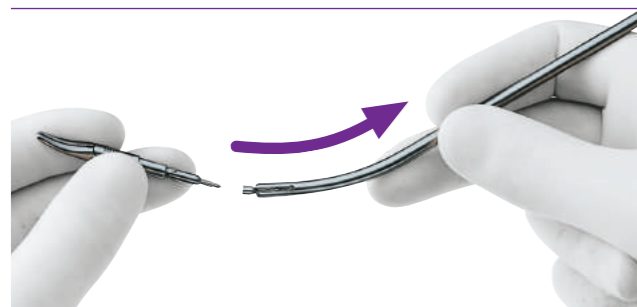

IX After unscrewing the jaw part, pull the tension rod backwards.

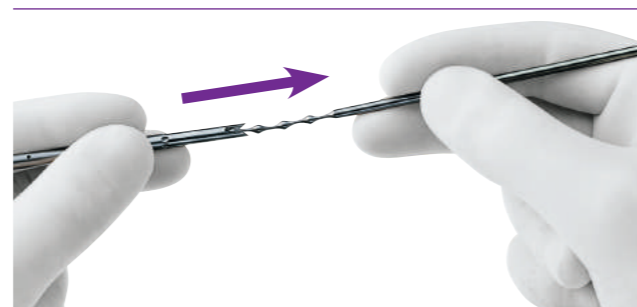

X Remove the complete tension rod in a backward direction from the inner tube.



XI Push insulated flexible outer tube PM983P onto the inner tube.



XII Press movable ring part of the handle forwards and hold at this position. Pull back spring mechanism of the axial handle as far as it will go and hold it. Take the shaft at the distal tip, push shaft into the spring mechanism as far as it will go and join with a slightly rotary movement.

AdTec® MONOPOLAR

CARE

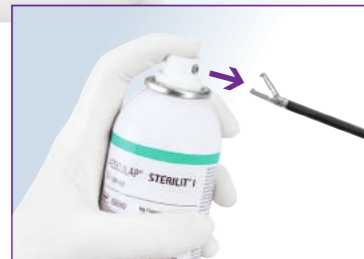

Lubricate the defined places on the instruments (instruments jaw and red toggle switch) with AESCULAP® Sterilit Oil after each cleaning cycle.



JG600 AESCULAP® Oil Spray in aerosol can, for maintenance of instruments prior to sterilization.

JG598 AESCULAP® Instrument Oil for box locks, ratchets etc. prior to sterilization.



GK469R Cleaning brush diam. 3.7 mm, length 550 mm for inner tube and outer tube diam. 5 mm. Package of 6 pieces.



PM995R Cleaning brush diam. 10 mm, length 550 mm for outer tube diam. 5 mm and diam. 10 mm. Package of 6 pieces.

AdTec® MONOPOLAR

NUMERICAL INDEX

Catalogue Number	Page	Catalogue Number	Page	Catalogue Number	Page	Catalogue Number	Page	Catalogue Number	Page		
GK239	57	JK490	61	PM630201	59	PM701R	17	P0001R	10	P0114R	26
GK245	57	JN445	61	PM630R	11	PM710R	9	P0002R	10	P0117R	40
GK246	57			PM635R	47	PM711R	37	P0003R	10	P0118R	34
GK299	57	PL170250	58	PM637R	51	PM712R	35	P0004R	6	P0127R	20
GK370P	55	PL170251	58	PM640R	27	PM713R	37	P0006R	10	P0128R	22
GK371P	56	PL170256	58	PM643R	53	PM719R	37	P0011R	8	P0129R	32
GK372R	55	PL170258	58	PM647R	15	PM940R	51, 53	P0014R	10	P0130R	30
GK373R	55 f.	PL960R	61	PM649R	41	PM950250	58	P0022R	6	P0132R	40
GK374R	55	PL961R	61	PM651R	35	PM950R	58	P0023R	8	P0134R	40
GK375R	55	PM009250	59	PM653R	47	PM951R	58	P0025R	10	P0137R	34
GK376P	55	PM009251	59	PM654R	49	PM953R	7 ff.	P0027R	6	P0141R	16
GK383R	55	PM171R	36	PM657R	35	PM954R	7 ff.	P0028R	8	P0147R	18
GK384R	55	PM173R	36	PM658R	35	PM955R	58	P0030R	8	P0149R	30
GK385R	55	PM175R	38	PM670R	29	PM957R	7 ff.	P0031R	8	P0151R	18
GK386R	55	PM176R	38	PM671R	39	PM970R	7 ff.	P0090R	6	P0152R	36
GK389R	56	PM177R	36	PM679R	31	PM971R	7 ff.	P0091R	6	P0185R	24
GK390R	56	PM178R	36	PM681R	33	PM973R	7 ff.	P0100R	14	P0186R	30
GK393R	55	PM434201	59	PM687R	29	PM974R	7 ff.	P0101R	18	P0187R	14
GK394R	55	PM600201	59	PM688R	43	PM975R	7 ff.	P0102R	12	P0188R	28
GK395R	55	PM604R	7	PM689R	39	PM976R	17 ff.	P0103R	16	P0189R	32
GK469R	67	PM609R	29	PM690R	37	PM977R	27 ff.	P0104R	28	P0190R	18
GN202	57	PM612R	29	PM693R	39	PM978R	17 ff.	P0105R	30	P0191R	24
		PM614R	15	PM696R	29	PM981R	7 ff.	P0107R	40	P0194R	42
JG598	67	PM616R	37	PM697R	7	PM982R	27, 59	P0109R	20	P0195R	14
JG600	67	PM618201	59	PM698R	9	PM983P	51 ff.	P0111R	42	P0196R	26
JK444	61	PM618R	25	PM699R	13	PM992R	11, 35, 59	P0112R	24	P0197R	26
JK489	61	PM621R	41	PM700R	17	PM995R	67	P0113R	26	P0199R	18

AdTec® MONOPOLAR

NUMERICAL INDEX

Catalogue Number	Page	Catalogue Number	Page	Catalogue Number	Page	Catalogue Number	Page	Catalogue Number	Page		
PO200R	32	PO229R	22	PO608R	13	PO648R	41	PO739R	43	PO769R	23
PO201R	40	PO230R	20	PO610R	29	PO650R	41	PO740R	15	PO770R	23
PO202R	12	PO231R	14	PO611R	31	PO652R	45	PO741R	27	PO771R	17
PO203R	18	PO232R	24	PO613R	41	PO655R	9	PO742R	27	PO772R	17
PO204R	24	PO233R	22	PO615R	21	PO657R	35	PO744R	11	PO773R	17
PO205R	26	PO234R	22	PO617R	43	PO661R	17	PO746R	7	PO774R	21
PO206R	30	PO235R	22	PO618R	25	PO667R	19	PO747R	19	PO775R	25
PO207R	32	PO236R	22	PO619R	27	PO668R	49	PO748R	15, 33	PO776R	25
PO208R	30	PO237R	12	PO620R	27	PO669R	51	PO749R	41	PO777R	43
PO209R	26	PO238R	12	PO623R	41	PO678R	19	PO750R	45	PO778R	43
PO210R	32	PO500R	44	PO624R	35	PO680R	31	PO751R	47	PO781R	35
PO211R	30	PO501R	44	PO625R	11	PO682R	11	PO752R	13	PO782R	23
PO212R	26	PO502R	46	PO626R	45	PO684R	37	PO753R	19	PO783R	21
PO213R	16	PO505R	44	PO627R	47	PO705R	45	PO754R	9	PO785R	25
PO214R	18	PO509R	44	PO628R	49	PO715R	9	PO755R	25	PO786R	23
PO215R	28	PO510R	46	PO631R	7	PO716R	9	PO756R	45	PO787R	23
PO216R	22	PO511R	44	PO632R	13	PO717R	13	PO757R	27	PO788R	23
PO217R	22	PO512R	46	PO633R	19	PO718R	13	PO758R	31	PO789R	23
PO218R	16	PO550R	48	PO634R	41	PO727R	7	PO759R	47	PO790R	7
PO219R	16	PO559R	48	PO636R	51	PO728R	25	PO761R	31	PO791R	7
PO220R	16	PO600R	11	PO638R	53	PO729R	31	PO762R	27	PO950400	58
PO221R	20	PO601R	11	PO641R	51	PO730R	15	PO763R	33	PO950410	58
PO222R	24	PO602R	11	PO642R	53	PO731R	29	PO764R	31	PO950420	58
PO223R	24	PO603R	7	PO644R	21	PO734R	33	PO765R	27	PO950R	58
PO224R	42	PO605R	15	PO645R	33	PO735R	19	PO766R	17	PO951R	58
PO225R	42	PO606R	17	PO646R	31	PO736R	25	PO767R	19	PO958R	7 ff.
PO228R	34	PO607R	19	PO647R	23	PO738R	9	PO768R	29	PO959R	7 ff.

AESCULAP[®] – a B. Braun brand

B. Braun Australia Pty Ltd | Level 5, 7-9 Irvine Place, Bella Vista NSW 2153
Tel. 1800 251 705 | customerservice.au@bbraun.com | www.bbraun.com.au

©2021 B. Braun Australia | BAUS AE E0713 08/21

The main product trademark "AESCULAP" and the product trademarks "AdTec" and "Sterilit" are registered trademarks of Aesculap AG.

Subject to technical changes. All rights reserved. This brochure may only be used for the exclusive purpose of obtaining information about our products. Reproduction in any form partial or otherwise is not permitted.