



SPINE SURGERY

AESCULAP® TSPACE® PEEK
TRANSFORAMINAL LUMBAR INTERBODY FUSION SYSTEM
SURGICAL MANUAL

AESCULAP® THORACOLUMBAR SPINE

PROTECTING AND PRESERVING SPINAL STABILITY

Modern lifestyle has resulted in increasing physical inactivity among people all over the world. Of the many medical problems associated with this, spinal disorders are among the most critical. This is even more significant as the spinal column is one of the most important structures in the human body.

It supports and stabilizes the upper body and is the center of our musculoskeletal system, which gives the body movement. Our work in the field of spine surgery is dedicated to protecting the spinal column and preserving its stability. We support spine surgeons with durable, reliable products and partner services for reliable procedures and good clinical outcomes (1-7).

Our philosophy of sharing expertise with healthcare professionals and patients allows us to develop innovative implant and instrument systems that help to preserve stability and stabilize the cervical and thoracolumbar spine.

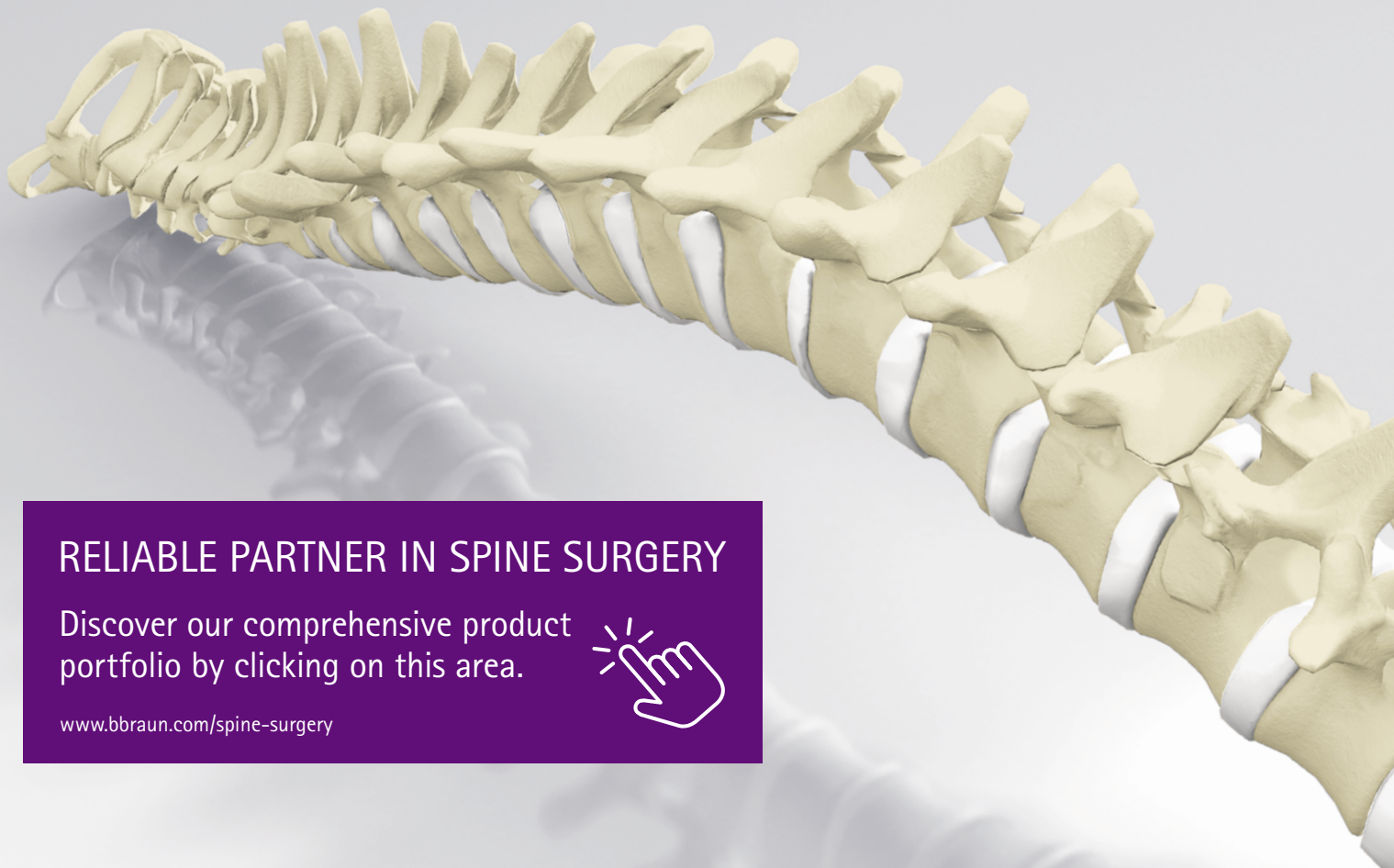

RELIABLE PARTNER IN SPINE SURGERY

Discover our comprehensive product portfolio by clicking on this area.



www.bbraun.com/spine-surgery

AESCULAP® TSPACE® PEEK

CONTENT



A GENERAL INFORMATION

B SURGICAL MANUAL

- B.1. POSITIONING OF THE PATIENT AND INCISION MARKING
- B.2. FASCIAL INCISION
- B.3. EXPOSURE AND BLUNT DISSECTION OF THE PARASPINAL MUSCLES
- B.4. INTRODUCTION OF THE SPINE CLASSICS RETRACTOR SYSTEM
- B.5. INSERTION OF PEDICLE SCREW
- B.6. REMOVAL OF FACET JOINT
- B.7. OPENING OF THE DISC AND REMOVAL OF DISC MATERIAL
- B.8. RESTORATION OF DISC HEIGHT
- B.9. CLEANING OF THE INTERVERTEBRAL SPACE
- B.10. DETERMINATION OF IMPLANT SIZE USING TRIAL
- B.11. REMOVAL OF THE TRIAL USING THE SLAP HAMMER SN320R
- B.12. IMPLANT INSERTION
- B.13. FINAL IMPLANT POSITIONING
- B.14. FINAL IMPLANT POSITION
- B.15. APPLICATION OF ROD AND SET SCREW
- B.16. PEDICLE SCREW POSITIONING ON THE CONTRA-LATERAL SIDE
- B.17. OVERVIEW OF THE ARTICULATING INSERTER SN305R

C IMPLANT & INSTRUMENT OVERVIEW

AESCULAP® TSPACE® PEEK

A | GENERAL INFORMATION

PHILOSOPHY

TSPACE® PEEK implants are used for stabilization of the lumbar and thoracic spine through transforaminal approach, monosegmental and multisegmental.

Always use TSPACE® PEEK implants in conjunction with an internal fixator.

> TSPACE® PEEK IS DESIGNED TO DELIVER

- PRIMARY STABILITY (8).
- RESTORATION OF THE NATURAL DISC HEIGHT AND LORDOSIS.

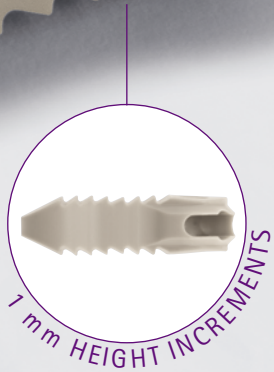
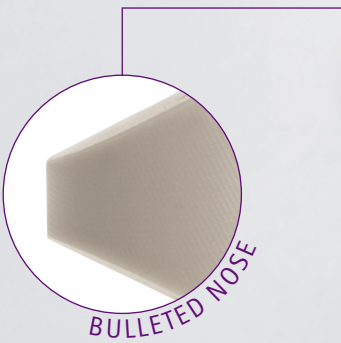
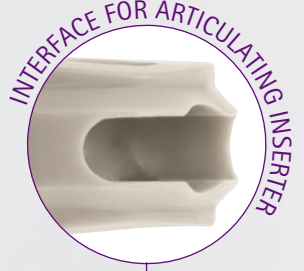
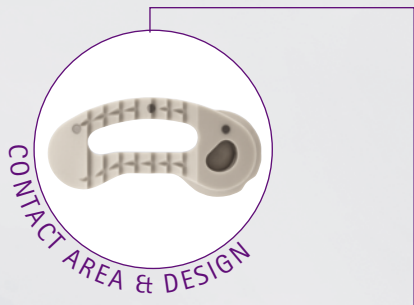

AESCULAP® TSPACE® PEEK

A | GENERAL INFORMATION

IMPLANT MATERIAL

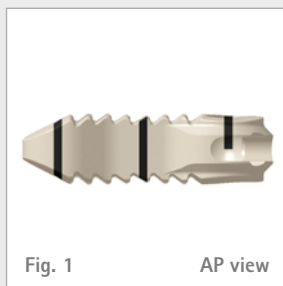

Fig. 1

AP view



Fig. 2

Lateral view

➤ The material used is biocompatible PEEK-OPTIMA®. PEEK stands for PolyEtherEtherKetone. PEEK-OPTIMA® polymer complies with ISO, ASTM and USP standards for use as a medical implant material.

The use of PEEK-OPTIMA® as an orthopaedic device material enjoys increased popularity due to the material's special combination of characteristics (9). Its properties include radiolucency, high mechanical strength, high fatigue resistance, a low wear factor and biocompatibility (10-14).

The intrinsic radioscopic transparency of the material provides permeability on X-rays and CT scans, allowing to visualize bone growth adjacent to the implant. This enables a quick and simple assessment of the bone structure and progress towards bone fusion (11). To verify the position of PEEK implants on radioscopic images, non-radiolucent tantalum markers were integrated serving as location indicators (Fig. 1/2).

Of particular interest is the modulus of elasticity of PEEK-OPTIMA®, which is similar to that of cortical bone. This modulus of elasticity may reduce implant subsidence and allow for improved bone growth (11, 15).

In vitro results of PEEK-OPTIMA® test specimens show a high long-term material stability after oxygen aging.* These results correspond with extensive biocompatibility investigations for PEEK-OPTIMA® proving the material suitable for use as a long-term implant (10, 11).

IMPLANT FEATURES

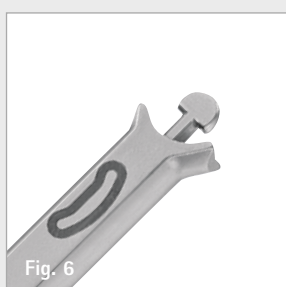
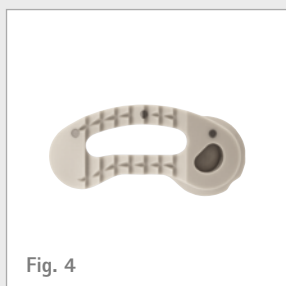
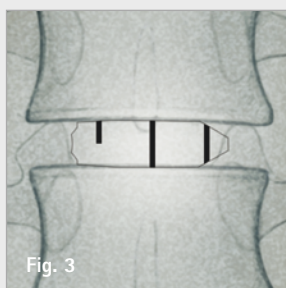

➤ POSITION VERIFICATION DESPITE X-RAY TRANSPARENCY

- The radiolucency of PEEK-OPTIMA® enables assessment of the bone structure and progress towards bone fusion (11).
- X-ray pins facilitating implant positioning and localization.

➤ IMPLANT DESIGN

- Anatomical shape and serrated profile aim for an implant fit and high primary stability.
- Option of filling with bone or bone substitute to enhance bone bridging.

➤ IMPLANT VARIETY

- Adequate range of sizes to enable the choice of implant size to fit the patient.

➤ INSTRUMENT DESIGN

- Specifically designed and clearly arranged instruments.
- Articulating inserter.
- Trials available for each implant size.

AESCALAP[®] TSPACE[®] PEEK

B | SURGICAL MANUAL

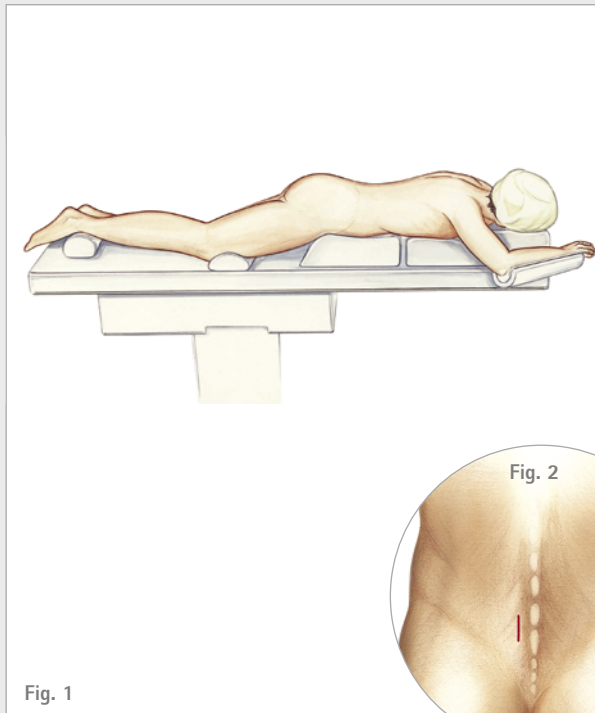

B.1. POSITIONING OF THE PATIENT AND INCISION MARKING

- A minimally invasive approach requires the patient to be placed on a radiolucent table which allows for AP views of the various anatomic structures (Fig. 1).
- The appropriate position of the longitudinal incision (4-5 cm in length) is determined by using a C-arm. The intended skin incision is marked paraspinally on the right and respectively on the left side (Fig. 2).

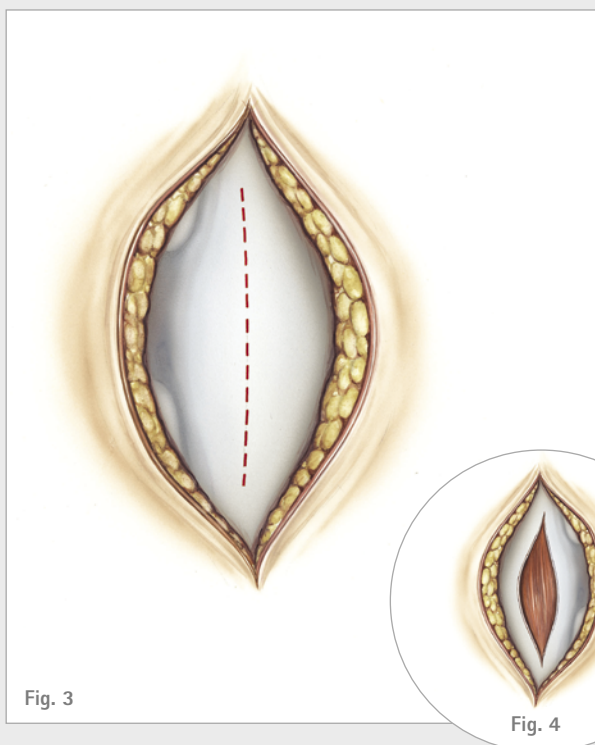

B.2. FASCIAL INCISION

- A slightly curved fascial incision 1.5 cm from the mid-line is performed. This allows a firm hold of the speculum and counter retractor, facilitating the exposure of the individual segment (Fig. 3 / 4).

B.3. EXPOSURE AND BLUNT DISSECTION OF THE PARASPINAL MUSCLES

- After splitting of the thoracolumbar fascia a blunt dissection of the paraspinal muscles is performed with the fingertip. In accordance with the palpatory finding, a correction of the skin incision is still possible, as the muscle retractor should be introduced as vertically as possible and in the direction of the interlaminar space. The length of the retractor is selected by using the index finger (Fig. 5/6).

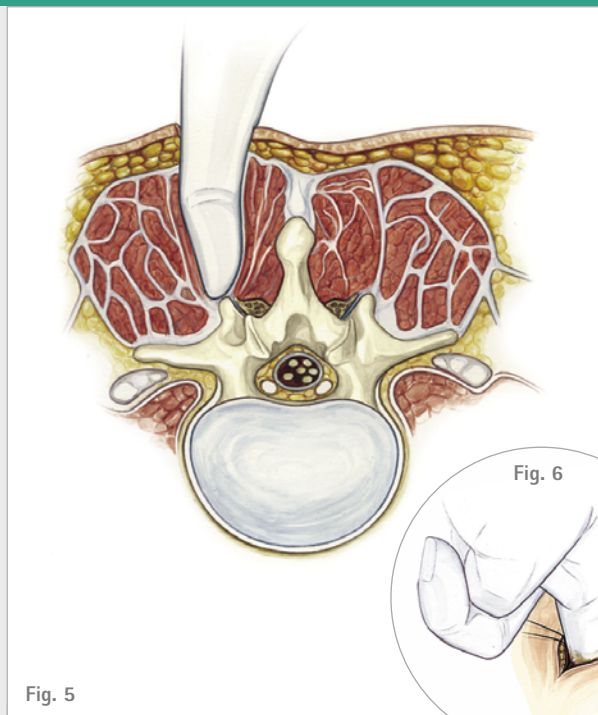

Fig. 5

B.4. INTRODUCTION OF THE SPINE CLASSICS RETRACTOR SYSTEM

- Spine Classics retractor system: see brochure O11402
- The muscle retractor is introduced with closed blades and with the handle in the longitudinal direction. It is then turned 90° and expanded (Fig. 7/8).

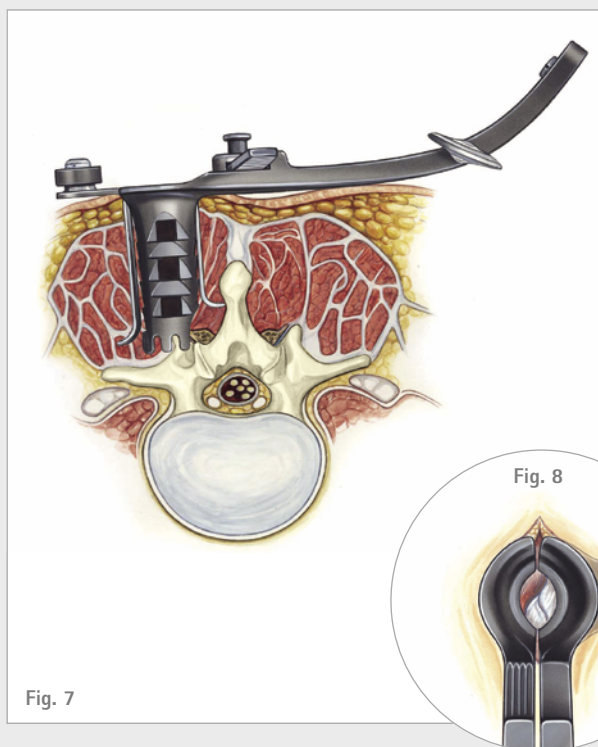
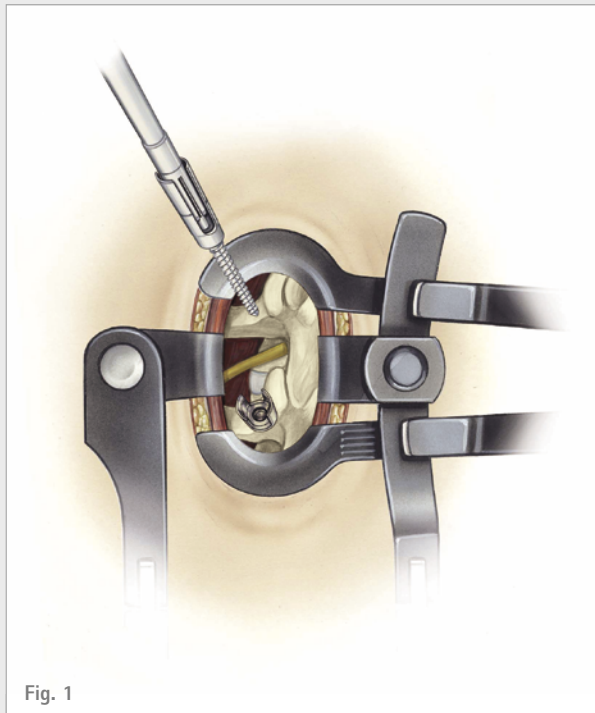

Fig. 7

AESCULAP® TSPACE® PEEK

B | SURGICAL MANUAL



B.5. INSERTION OF PEDICLE SCREW

- Using the standard technique, the pedicle screws are inserted, e. g. AESCULAP® Ennovate® (Fig. 1).

For more information please visit www.bbraun.com/ennovate

INFORMATION

Thoracolumbar pedicle screw system shown in images is the AESCULAP® S⁴® Spinal System.

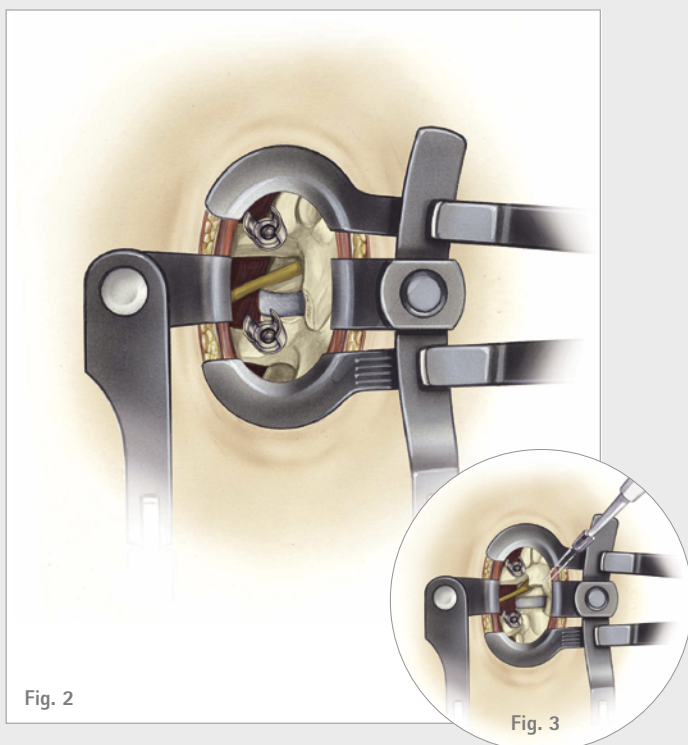

B.6. REMOVAL OF FACET JOINT

- A complete unilateral facetectomy should be considered on the side targeted for the implant insertion, for which an osteotome may be used. The inferior articular process of the facet joint is resected first, then the subjacent superior articular process is resected (Fig 2/3).

B.7. OPENING OF THE DISC AND REMOVAL OF DISC MATERIAL

- To open the disc a small window is cut into the annulus (Fig. 4).
- Rongeurs are used to remove the opened annulus (Fig. 5).
- Posterior osteophytes are removed by using Kerrisons.

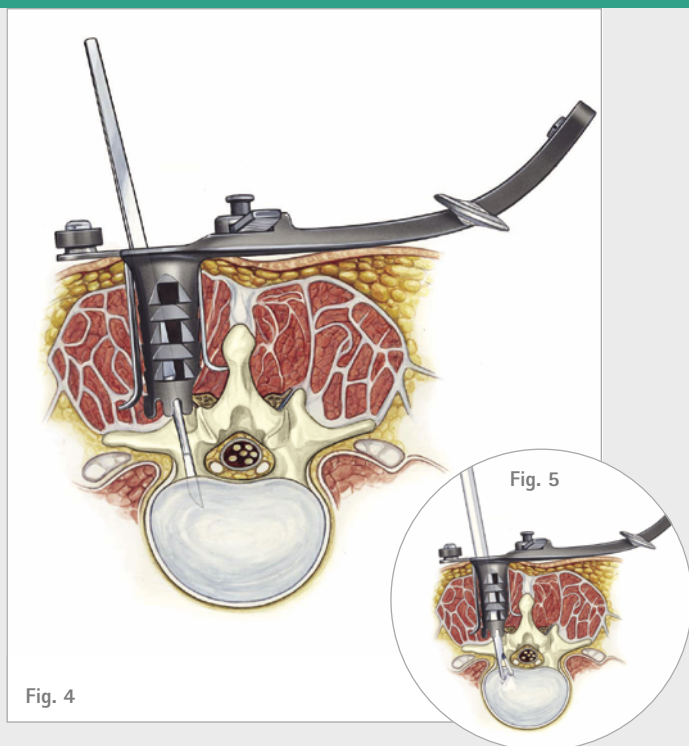

Fig. 4

Fig. 5

B.8. RESTORATION OF DISC HEIGHT

- The desired restoration of the natural disc height can be set using the distractors. They are available in heights from 7 - 17 mm in 2 mm increments and can be attached to the t-handle in the set.
- The distractor must be inserted horizontally and then rotated. Rotating clockwise the distractors are blunt and allow for a blunt height restoration maneuver. Rotating counterclockwise the distractors have a specially designed sharp rim to allow for removal of disc material (Fig. 6).

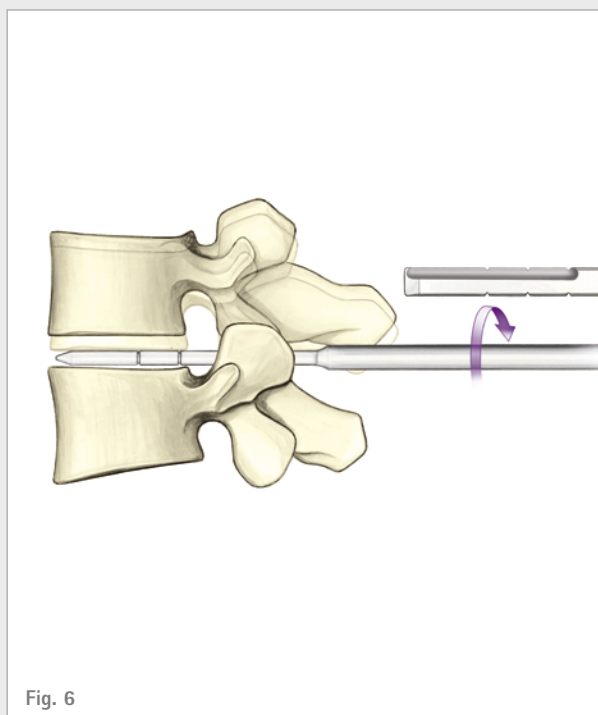
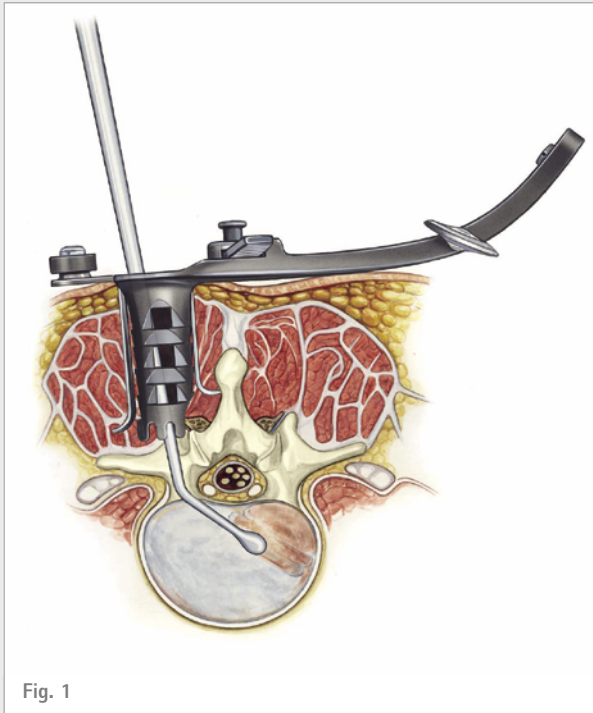

Fig. 6

AESCULAP® TSPACE® PEEK

B | SURGICAL MANUAL



B.9. CLEANING OF THE INTERVERTEBRAL SPACE

- The disc space is cleared using rongeurs, bone currettes and box currettes (Fig. 1).
- The bone rasps are used for endplate preparation.
- Alternatively, the box currettes can be used.

INFORMATION

Make certain that the endplates of the neighboring vertebral bodies are not weakened, in order to minimize the risk of migration.

Make certain that the implant bed is properly prepared to avoid damage to the implant when it is driven in.

Use the nerve root retractors to protect the dura during insertion.

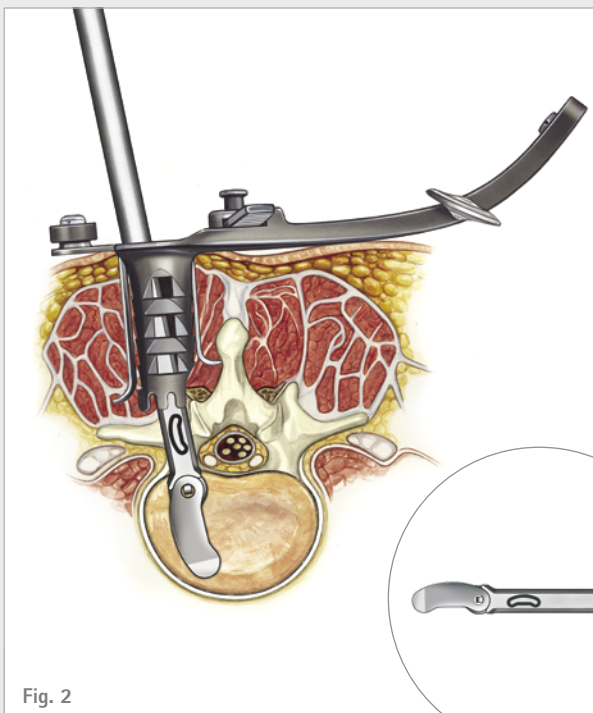

B.10. DETERMINATION OF IMPLANT SIZE USING TRIAL

- The TSPACE® PEEK trials are available for each implant size.
- Use the articulating inserter with the TSPACE® PEEK trials until the desired position is reached. The trial positioning is done in the same way as the implant positioning (Fig. 2/3).
- Please refer to pages 14 and 15 for the description of the insertion steps.

INFORMATION

Please refer to page 17 for a detailed handling description of the articulating inserter.

The trials are essential to ensure the correct implant size to be used.



B.11. REMOVAL OF THE TRIAL USING THE SLAP HAMMER SN320R

- Connect the slap hammer to the handle of the articulating inserter by engaging the slap hammer with the interface on the distal end of the articulating inserter.
- Use the slap hammer to back out the trial carefully (Fig. 4).

INFORMATION

The inserter knob should be loose when backing out the trial.

If the inserter knob is released more than a 1/4 turn counter-clockwise the trial implant may disengage from the inserter.

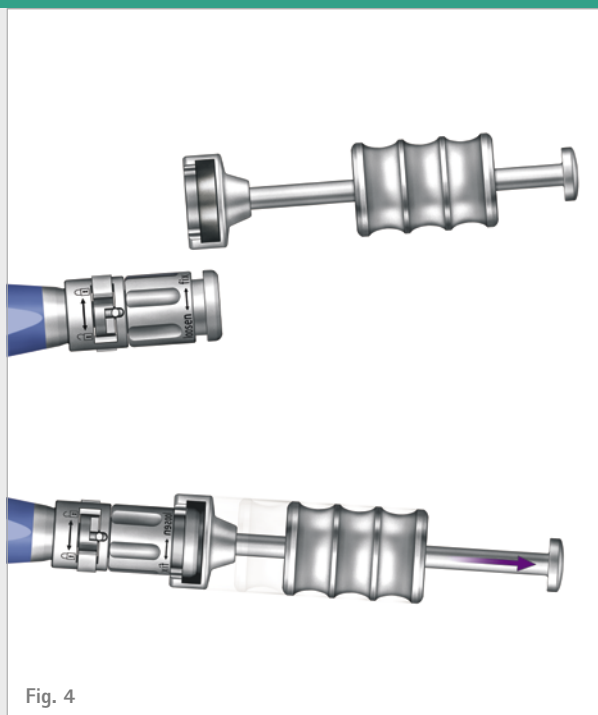

AESCULAP® TSPACE® PEEK

B | SURGICAL MANUAL

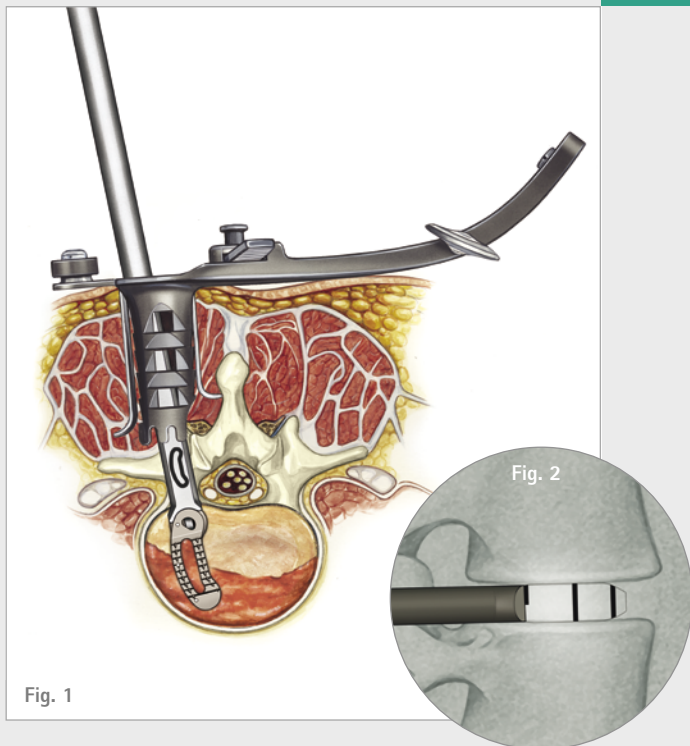

B.12. IMPLANT INSERTION

- Use the packing block to fill the TSPACE® PEEK grafting window with bone or bone substitute.

INFORMATION

- Do not use excessive force when filling, mounting or implanting the implant to avoid damaging.
- Mount the implant on the insertion instrument hand-tight.
- To start the insertion, fix the implant at 0° position to the inserter and recheck the connection between the trial / implant and the inserter.
- Use the nerve retractors to protect the dura during insertion.
- When inserting the implant into the intervertebral space, avoid canting and levering, and take care to maintain an alignment parallel to the endplate.

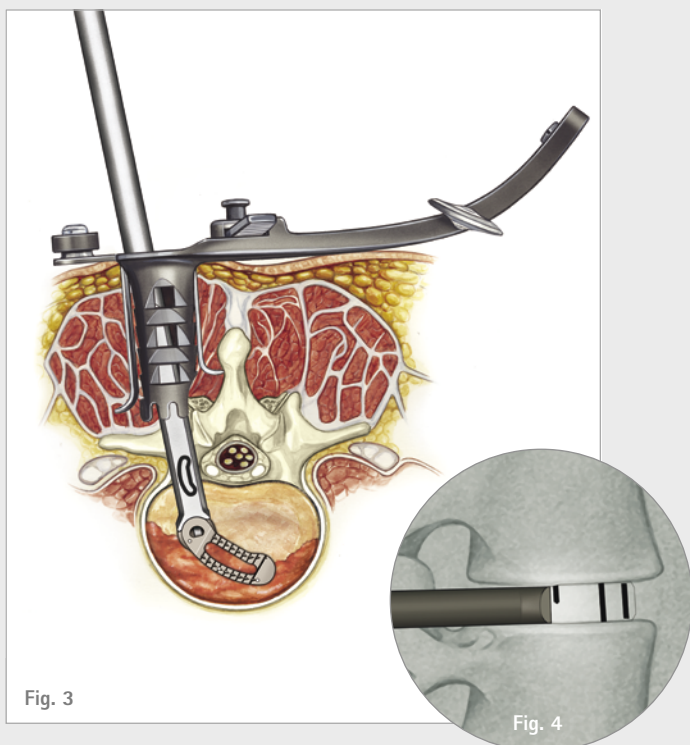

- It is recommended to place bone graft in the anterior part.
- Insert the TSPACE® PEEK interbody implant completely into the disc space with the inserter (Fig. 1/2).
- To use the articulation feature of the inserter release the implant/trial implant by turning the knob 1/4 turn counterclockwise (direction "loosen") after the interbody implant is completely inside the disc space.
- Use the integrated X-ray markers to verify the implant position during the insertion process (Fig. 3/4).

INFORMATION

To avoid premature disengagement of the implant/trial implant from the articulating inserter do not loosen the implant/trial implant completely before the intended end position has been reached.



Fig. 5

B.13. FINAL IMPLANT POSITIONING

- Use the articulating inserter to rotate the implant up to 90° to achieve the final positioning (Fig. 5).
- X-ray control to verify the implant positioning (Fig. 6).
- Release the implant after the final position is reached and remove the inserter (Fig. 7).
- If there is a need for repositioning of the implant, the impactor could be used.
- It is recommended to place bone material harvested from the facet joint around the TSPACE® PEEK implant.

INFORMATION

Please refer to page 17 for a detailed handling description of the articulating inserter.

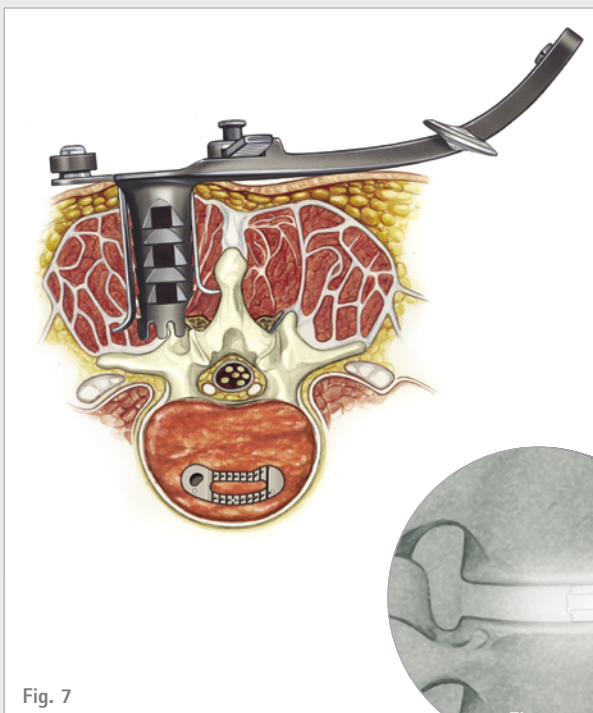

Fig. 7

B.14. FINAL IMPLANT POSITION

- Observe the X-ray markers in both the AP and lateral views to ensure that the implant is placed well within the disc space (Fig. 8/9).
- On the lateral fluoroscopic image the two lateral markers should appear as one line.
- On the AP fluoroscopic image all three markers are visible and the anterior marker should be in the midline.

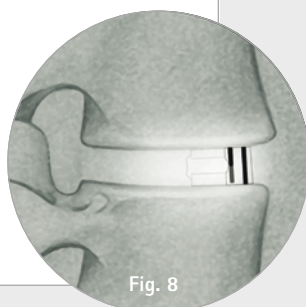

Fig. 8

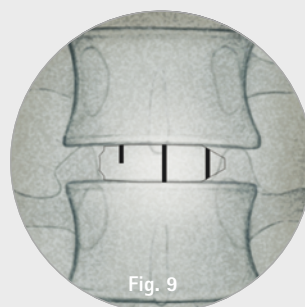

Fig. 9

AESFULAP[®] TSPACE[®] PEEK

B | SURGICAL MANUAL

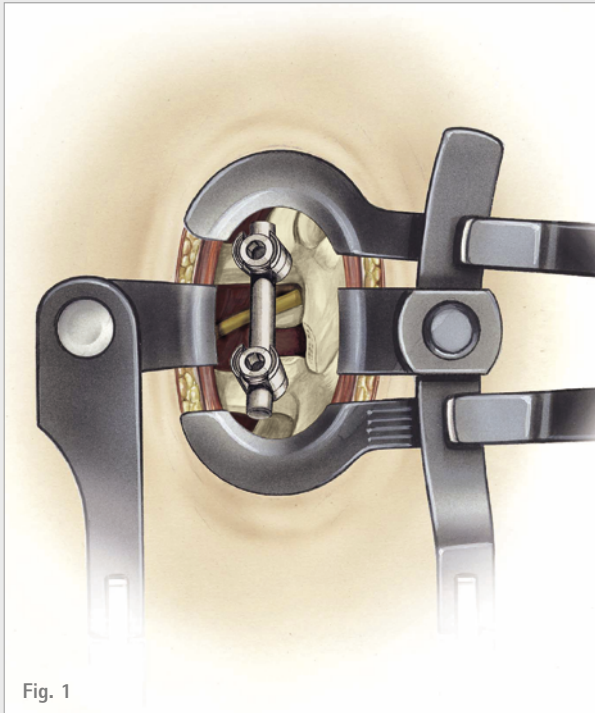

Fig. 1

B.15. APPLICATION OF ROD AND SET SCREW

- Final assembly of the thoracolumbar pedicle screw system (Fig. 1).
- Compression is applied to the pedicle screws to support the contact area between the TSPACE[®] PEEK implant and the endplates.
- Final tightening of the pedicle screws and closure.

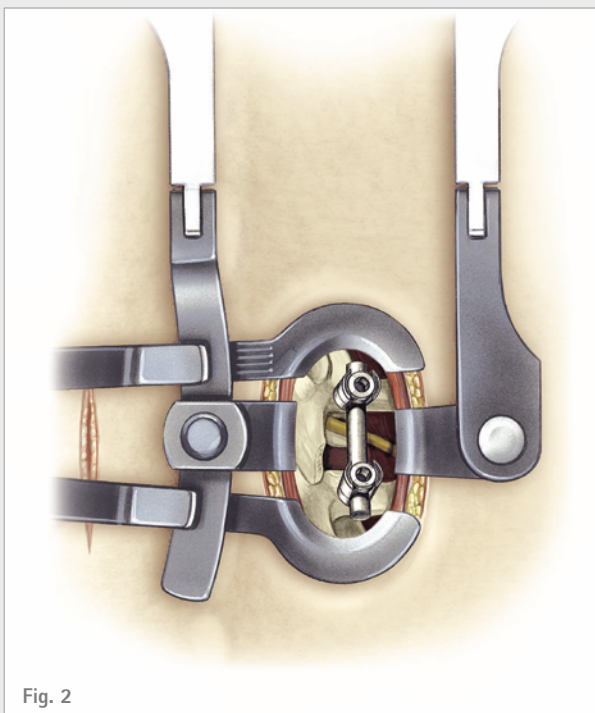

Fig. 2

B.16. PEDICLE SCREW POSITIONING ON THE CONTRA-LATERAL SIDE

- Thoracolumbar pedicle screw system is applied on the contra-lateral side (Fig. 2).

To view our full portfolio please visit www.bbraun.com

INFORMATION

Thoracolumbar pedicle screw system shown in images is the AESFULAP[®] S4[®] Spinal System.

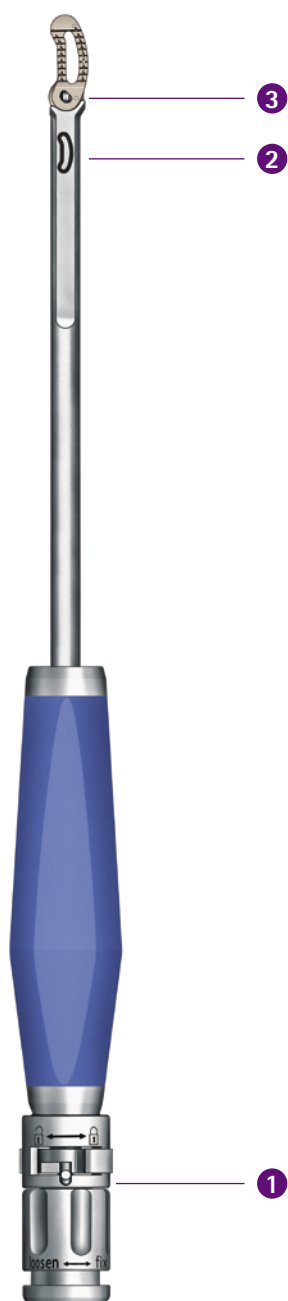

Fig. 3

B.17. OVERVIEW OF THE ARTICULATING INSERTER SN305R

- The inserter allows continuous articulation enabling an adjustable interbody positioning of the implant between 0° and up to 90°.
- A controlled insertion is possible as the interbody device is always connected to the inserter during the positioning process.
- The most important parts of the inserter are (Fig. 3):
 - ① The "control" part consisting of the open/close switch and the rotation knob to handle the trial positioning and implant insertion steps.
 - ② The visual marking on the end of the inserter shaft which determines the loading direction of the trial/implant.
 - ③ The loading part with the tip of the insertion rod where the trial/implant will be connected.
- See a detailed description on the handling of the articulating inserter on the following pages.

INFORMATION

Alternatively, the inserter SN705R can be used for TSPACE® PEEK with articulating interface. For detailed information see IFU TA015946.

AESCULAP® TSPACE® PEEK

B | SURGICAL MANUAL

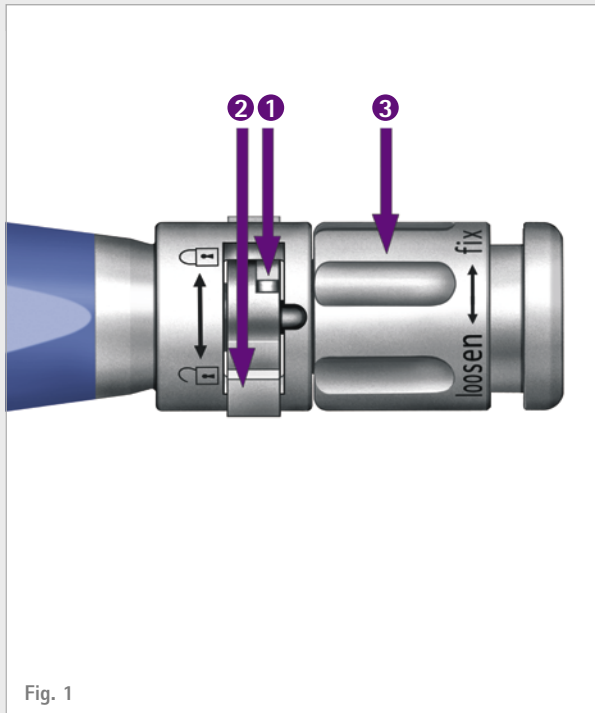



Fig. 1

FUNCTIONALITY OF THE ARTICULATING INSERTER SN305R (FIG. 1)

- The pin **1** is used to indicate the position of the insertion rod.
- The switch **2** is used to load the implant/trial to the inserter. By turning the switch to the locked position  the implant/trial will be loaded.
- The knob **3** is used to tighten the implant/trial that is loaded. By turning the knob clockwise (direction "fix") the insertion rod protruding out of the shaft tip is moved back in the shaft and tightens the implant/trial.
- Turning the knob counterclockwise (direction "loosen") will do the reverse, loosening the implant/trial implant.

START POSITION FOR IMPLANT CONNECTION (FIG. 1)

- Rotate the knob **3** counterclockwise to move the insertion rod forward (direction "loosen") until the pin **1** is visible inside of the window.
- Turn the switch **2** to the unlocked position .

INFORMATION

Please check all visual markings on the handle before you start operating the inserter.

Further information about the handling of the inserter is available in the instructions for use document.

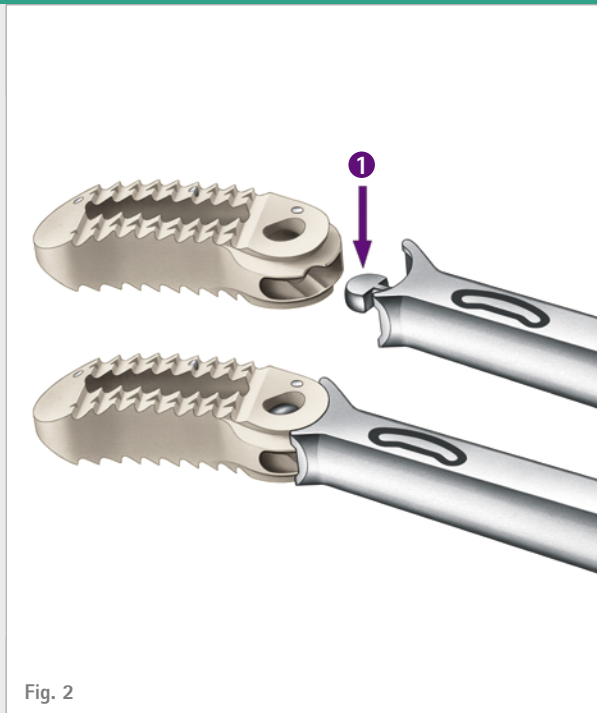

Fig. 2

LOADING OF THE IMPLANT/TRIAL (FIG. 2)

- Ensure the tip of the insertion rod ❶ is fully protruded in its horizontal position.
- Connect the tip of the insertion rod with the implant/trial. The orientation of the implant/trial should match the visual marking on the end of the instrument shaft.

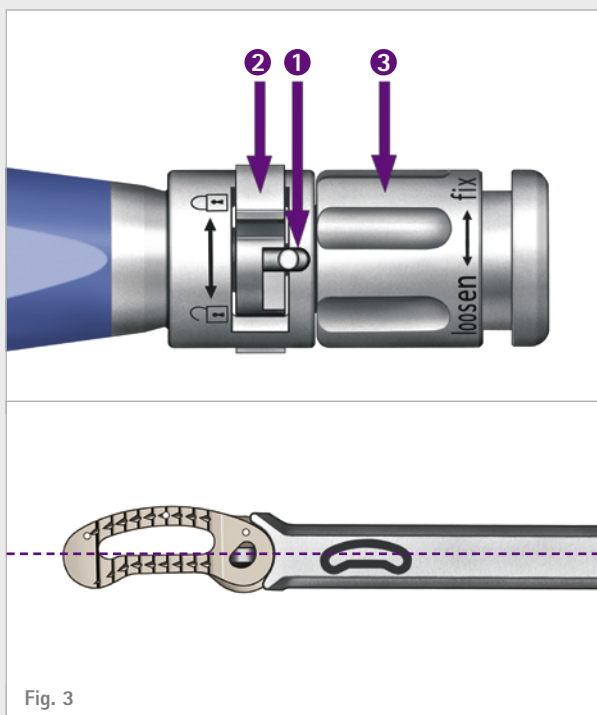



Fig. 3

LOCKING AND FIXATION OF THE IMPLANT/TRIAL IN 0° POSITION (FIG. 3)

- To lock the implant/trial and fix it at a 0° position place the implant straight and turn the switch ❷ to the locked position .
- Rotate the knob ❸ clockwise to sink the insertion rod back (direction "fix") into the instrument and fix the implant/trial. The pin ❶ should be on the outer side of the window and the knob is tightened completely.
- This is the initial position to start the implantation of the implant/trial.

AESCULAP® TSPACE® PEEK

B | SURGICAL MANUAL

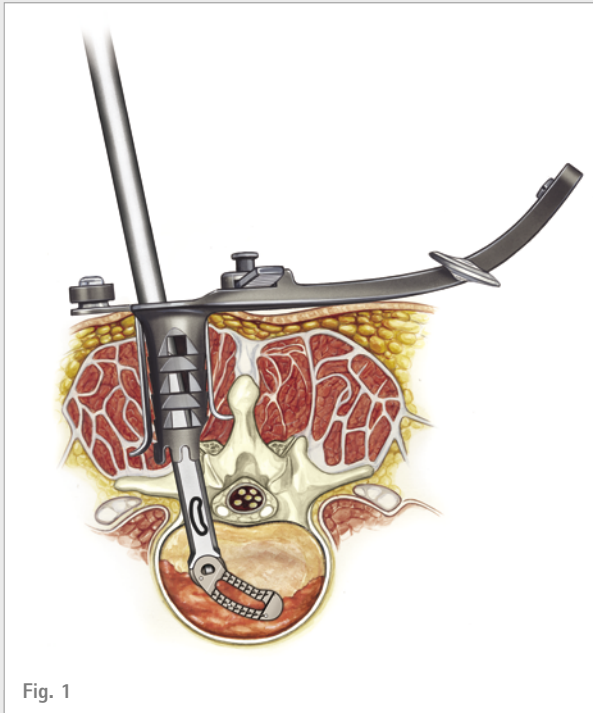

Fig. 1

USE OF THE ARTICULATION FEATURE FOR IMPLANT/ TRIAL POSITIONING (FIG. 1)

- To use the articulation feature of the inserter release the implant/trial by turning the knob 1/4 turn counterclockwise (direction "loosen"). This will move the insertion rod forward and loose the implant/trial.
- To fix the implant in-between rotate the knob clockwise to move the rod backward (direction "fix") into the instrument until the knob is tightened completely.

INFORMATION

Do not loose the implant/trial completely until the end position of the implant is reached or the trial should be removed outside of the patient.

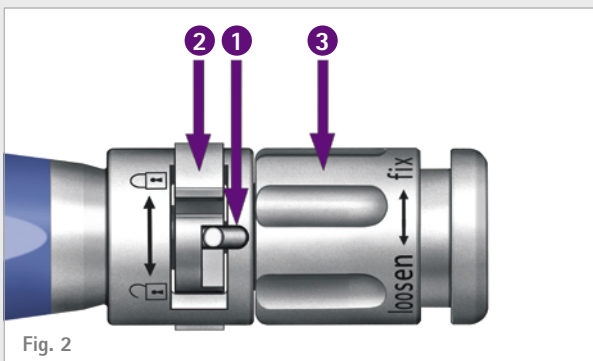



Fig. 2

INSERT THE IMPLANT OR REMOVE THE TRIAL (FIG. 2/3)

- To disengage the implant after the final position is reached or to disengage the trial the following steps are necessary.
- Turn the knob **3** counterclockwise to move the insertion rod forward (direction "loosen") until the pin **1** is visible inside of the window.
- Turn the switch **2** to the unlocked position .
- Disconnect the inserter from the implant/trial.

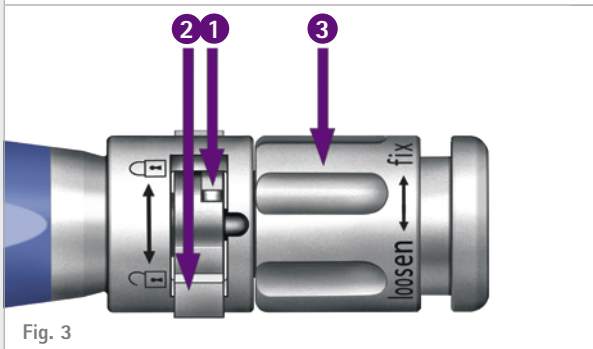
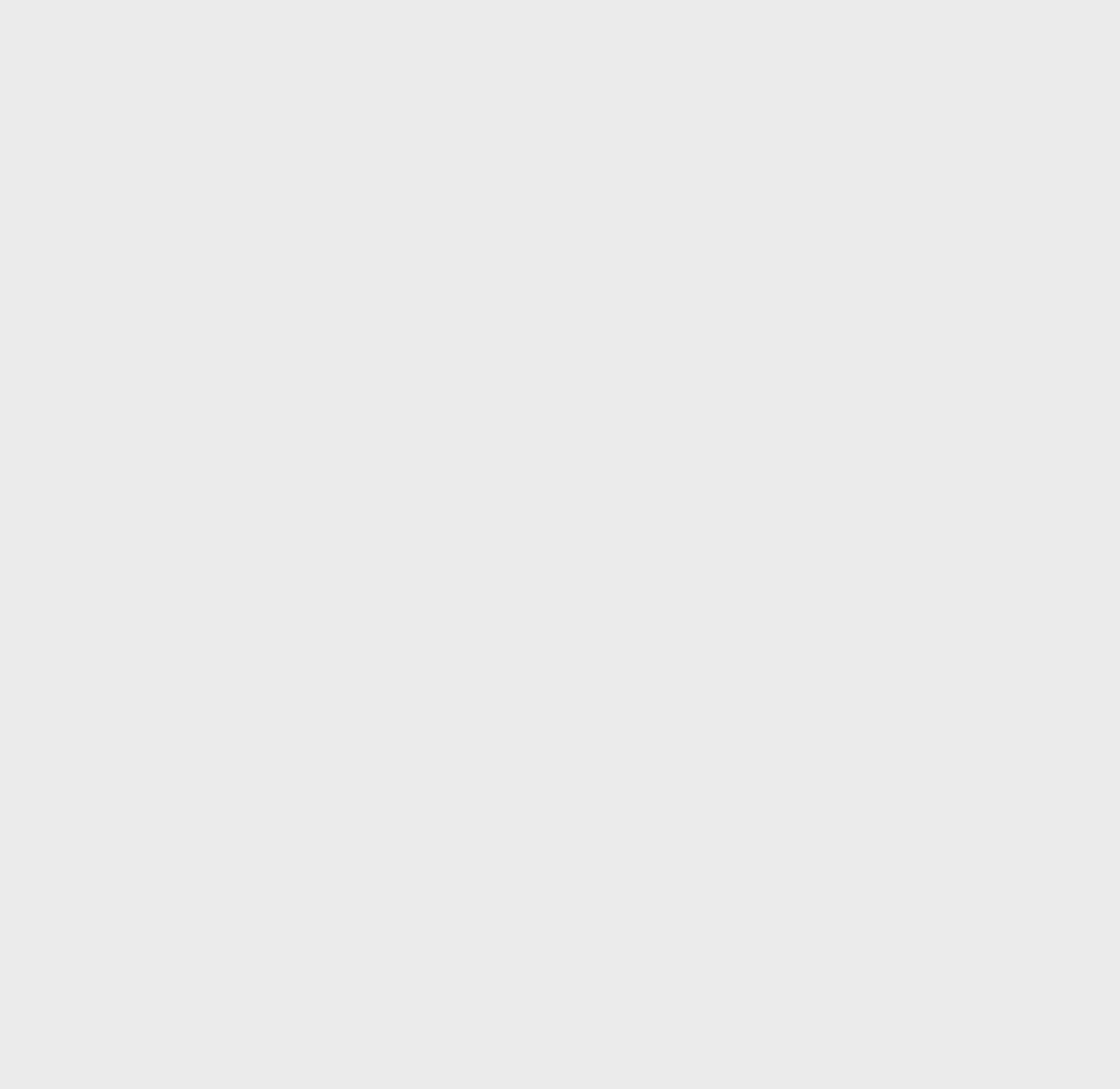

Fig. 3

INFORMATION

When releasing the implant/trial, ensure that the knob is not over tightened as it may impede the switch changing positions.



AESCULAP® TSPACE® PEEK

C | IMPLANT & INSTRUMENT OVERVIEW

TSPACE® PEEK IMPLANTS

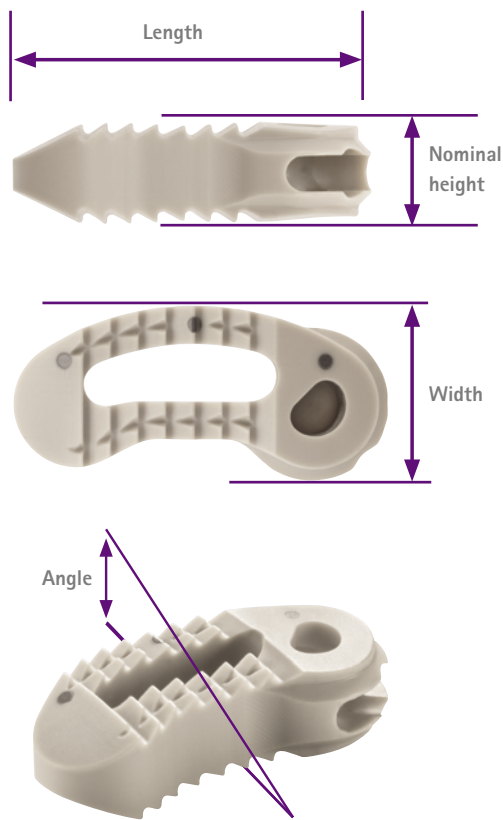



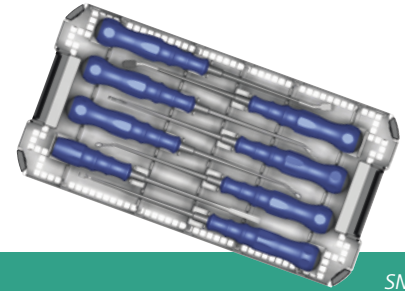

| Article No. | Size (Length x Width x Height) | Angle |
|-------------|---------------------------------|-------|
|-------------|---------------------------------|-------|

| | | |
|--------|-------------------|----|
| SN307P | 26 x 11.5 x 7 mm | 5° |
| SN308P | 26 x 11.5 x 8 mm | 5° |
| SN309P | 26 x 11.5 x 9 mm | 5° |
| SN310P | 26 x 11.5 x 10 mm | 5° |
| SN311P | 26 x 11.5 x 11 mm | 5° |
| SN312P | 26 x 11.5 x 12 mm | 5° |
| SN313P | 26 x 11.5 x 13 mm | 5° |
| SN314P | 26 x 11.5 x 14 mm | 5° |
| SN315P | 26 x 11.5 x 15 mm | 5° |
| SN317P | 26 x 11.5 x 17 mm | 5° |
| SN337P | 30 x 11.5 x 7 mm | 5° |
| SN338P | 30 x 11.5 x 8 mm | 5° |
| SN339P | 30 x 11.5 x 9 mm | 5° |
| SN340P | 30 x 11.5 x 10 mm | 5° |
| SN341P | 30 x 11.5 x 11 mm | 5° |
| SN342P | 30 x 11.5 x 12 mm | 5° |
| SN343P | 30 x 11.5 x 13 mm | 5° |
| SN344P | 30 x 11.5 x 14 mm | 5° |
| SN345P | 30 x 11.5 x 15 mm | 5° |
| SN347P | 30 x 11.5 x 17 mm | 5° |
| SN367P | 34 x 11.5 x 7 mm | 5° |
| SN368P | 34 x 11.5 x 8 mm | 5° |
| SN369P | 34 x 11.5 x 9 mm | 5° |
| SN370P | 34 x 11.5 x 10 mm | 5° |
| SN371P | 34 x 11.5 x 11 mm | 5° |
| SN372P | 34 x 11.5 x 12 mm | 5° |
| SN373P | 34 x 11.5 x 13 mm | 5° |
| SN374P | 34 x 11.5 x 14 mm | 5° |
| SN375P | 34 x 11.5 x 15 mm | 5° |
| SN377P | 34 x 11.5 x 17 mm | 5° |

SN300 – TSPACE® PEEK INSTRUMENTATION



SN301R
TSPACE® PEEK – Preparation Tray

| INSTRUMENTS | Article No. | Description | Quantity |
|---|-------------|----------------------------------|----------|
|  | FJ679R | Left angled bone curette, 45° | 1 |
| | FJ680R | Right angled bone curette, 45° | 1 |
| | FJ698R | Left angled bone curette, 20° | 1* |
| | FJ699R | Right angled bone curette, 20° | 1* |
|  | FJ681R | Straight curette | 1 |
|  | FJ682R | Left angled curette, 45° | 1 |
| | FJ683R | Right angled curette, 45° | 1 |
| | FJ702R | Left angled curette, 20° | 1* |
| | FJ703R | Right angled curette, 20° | 1* |
|  | FJ658R | Straight osteotome, 8 mm | 1 |
|  | FJ685R | Left angled bone rasp, 45° | 1 |
| | FJ686R | Right angled bone rasp, 45° | 1 |
| | FJ704R | Left angled bone rasp, 20° | 1* |
| | FJ705R | Right angled bone rasp, 20° | 1* |
| | SN301R | Tray for preparation instruments | 1 |
| | JA455R | Lid for AESCULAP® OrthoTray® | 1 |
| | TF219 | Packing stencil for SN301R | 1 |

*This article is optional.
Recommended container for SN301R: JK441 / JN441 and lid JK489.

AESCULAP® TSPACE® PEEK

C | IMPLANT & INSTRUMENT OVERVIEW

SN300 – TSPACE® PEEK INSTRUMENTATION

| INSTRUMENTS | Article No. | Description | Quantity |
|--|-------------------------------------|------------------------------------|----------|
|  | FJ647R | Distractor, 7 mm | 1 |
| | FJ648R | Distractor, 8 mm | 1 |
| | FJ649R | Distractor, 9 mm | 1 |
| | FJ650R | Distractor, 10 mm | 1 |
| | FJ651R | Distractor, 11 mm | 1 |
| | FJ652R | Distractor, 12 mm | 1 |
| | FJ653R | Distractor, 13 mm | 1 |
| | FJ654R | Distractor, 14 mm | 1 |
| | FJ655R | Distractor, 15 mm | 1 |
| | FJ657R | Distractor, 17 mm | 1 |
| | SN322R | TSPACE® PEEK/XP/3D trial 26 x 7 mm | 1 |
| | SN323R | TSPACE® PEEK/XP/3D trial 26 x 8 mm | 1 |
| SN324R | TSPACE® PEEK/XP/3D trial 26 x 9 mm | 1 | |
| SN325R | TSPACE® PEEK/XP/3D trial 26 x 10 mm | 1 | |
| SN326R | TSPACE® PEEK/XP/3D trial 26 x 11 mm | 1 | |
| SN327R | TSPACE® PEEK/XP/3D trial 26 x 12 mm | 1 | |
| SN328R | TSPACE® PEEK/XP/3D trial 26 x 13 mm | 1 | |
| SN329R | TSPACE® PEEK/XP/3D trial 26 x 14 mm | 1 | |
| SN330R | TSPACE® PEEK/XP/3D trial 26 x 15 mm | 1 | |
| SN332R | TSPACE® PEEK/XP/3D trial 26 x 17 mm | 1 | |

| INSTRUMENTS | Article No. | Description | Quantity |
|-------------|-------------|-------------------------------------|----------|
| | SN352R | TSPACE® PEEK/XP/3D trial 30 x 7 mm | 1 |
| | SN353R | TSPACE® PEEK/XP/3D trial 30 x 8 mm | 1 |
| | SN354R | TSPACE® PEEK/XP/3D trial 30 x 9 mm | 1 |
| | SN355R | TSPACE® PEEK/XP/3D trial 30 x 10 mm | 1 |
| | SN356R | TSPACE® PEEK/XP/3D trial 30 x 11 mm | 1 |
| | SN357R | TSPACE® PEEK/XP/3D trial 30 x 12 mm | 1 |
| | SN358R | TSPACE® PEEK/XP/3D trial 30 x 13 mm | 1 |
| | SN359R | TSPACE® PEEK/XP/3D trial 30 x 14 mm | 1 |
| | SN360R | TSPACE® PEEK/XP/3D trial 30 x 15 mm | 1 |
| | SN362R | TSPACE® PEEK/XP/3D trial 30 x 17 mm | 1 |
| | SN382R | TSPACE® PEEK/XP/3D trial 34 x 7 mm | 1 |
| | SN383R | TSPACE® PEEK/XP/3D trial 34 x 8 mm | 1 |
| | SN384R | TSPACE® PEEK/XP/3D trial 34 x 9 mm | 1 |
| | SN385R | TSPACE® PEEK/XP/3D trial 34 x 10 mm | 1 |
| | SN386R | TSPACE® PEEK/XP/3D trial 34 x 11 mm | 1 |
| | SN387R | TSPACE® PEEK/XP/3D trial 34 x 12 mm | 1 |
| | SN388R | TSPACE® PEEK/XP/3D trial 34 x 13 mm | 1 |
| | SN389R | TSPACE® PEEK/XP/3D trial 34 x 14 mm | 1 |
| | SN390R | TSPACE® PEEK/XP/3D trial 34 x 15 mm | 1 |
| | SN392R | TSPACE® PEEK/XP/3D trial 34 x 17 mm | 1 |





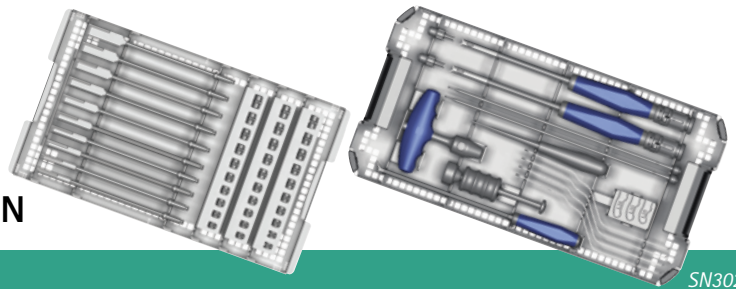

AESCULAP® TSPACE® PEEK

C | IMPLANT & INSTRUMENT OVERVIEW

SN300 – TSPACE® PEEK INSTRUMENTATION

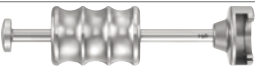

SN302R
TSPACE® PEEK – Implantation Tray

| INSTRUMENTS | Article No. | Description | Quantity |
|---|-------------|-------------------------------------|----------|
|  | SJ033R | T-handle for distractors and trials | 1 |
|  | FJ051R | Retractor S | 1 |
| | FJ052R | Retractor M | 1 |
| | FJ053R | Retractor L | 1 |
| | FJ054R | Retractor XL | 1 |
|  | FF913R | Graft positioning tamp | 1 |
|  | SN304R | Packing block | 1 |
|  | SN320R | Slap hammer | 1 |
|  | SN305R | TSPACE® PEEK/XP inserter | 2 |
|  | FJ613R | Impactor | 1 |
| | SN302R | Tray for implantation instruments | 1 |
| | JA455R | Lid for AESCULAP® OrthoTray® | 1 |
| | TF220 | Packing stencil for SN302R | 1 |

REFERENCES

- (1) Tropiano P, Bronsard JJ, Louis C, Tallet JM, Sauget Y. Three column stabilisation through a posterior approach with a titanium PLASMAPORE® intervertebral block (PROSPACE®). Radiological and clinical study after 4 years. *Rivista di Neuroradiologia*. 1999;12(Suppl 1):89-94.
- (2) Kroppenstedt S, Gulde M, Schonmayr R. Radiological comparison of instrumented posterior lumbar interbody fusion with one or two closed-box PLASMAPORE® coated titanium cages. Follow-up study over more than seven years. *Spine*. 2008;33(19):2083-8.
- (3) Kreinest M, Schmahl D, Grutzner PA, Matschke S. Radiological Results and Clinical Patient Outcome After Implantation of a Hydraulic Expandable Vertebral Body Replacement following Traumatic Vertebral Fractures in the Thoracic and Lumbar Spine: A 3-Year Follow-Up. *Spine (Phila Pa 1976)*. 2017 Apr 15;42(8):E482-E489.
- (4) Takeuchi M, Yasuda M, Niwa A, Wakao N, Nakura T, Osuka K et al. PLASMAPORE®-coated titanium cervical cages induce more rapid and complete bone fusion after anterior cervical discectomy and fusion as compared to noncoated titanium cage. *World Neurosurgery*. 2014;82(3/4):519-22.
- (5) Vanek P, Bradac O, Konopkova R, de Lacy P, Lacman J, Benes V. Treatment of thoracolumbar trauma by short-segment percutaneous transpedicular screw instrumentation: prospective comparative study with a minimum 2-year follow-up. *J Neurosurg Spine*. 2014;20:150-6.
- (6) Beisse R. Endoscopic surgery on the thoracolumbar junction of the spine. *Eur Spine J*. 2006;15:687-704.
- (7) Kurtz SM, Devine JN. PEEK biomaterials in trauma, orthopedic and spinal implants. *Biomaterials*. 2007;28(32):4845-69.
- (8) Mechanical testing of the AESCULAP® TSPACE® PEEK 3rd Generation implant evaluating shear resistance. Tuttlingen, 2015. The AESCULAP® TSPACE® PEEK 3rd Generation implant was tested in a shear force test following internal standards to evaluate the risk of implant dislocation related to shear forces occurring in situ. For this test, a synthetic bone-equivalent polyurethane test block was used. A quasi-static shear force was applied to the implant. The implant was axially loaded during the whole test with a constant force to simulate a clinically relevant loading situation. Based on the maximum shear load obtained in the test, the risk of implant dislocation due to shear forces at a physiological load situation is unlikely to occur in the case of the AESCULAP® TSPACE® PEEK 3rd Generation implant.
- (9) Kurtz SM, Devine JN. PEEK biomaterials in trauma, orthopedic, and spinal implants. *Biomaterials* 2007; 28(32):4845-69.
- (10) Morrison C, Macnair R, MacDonald C, Wykman A, Goldie I, Grant MH. In vitro biocompatibility testing of polymers for orthopaedic implants using cultured fibroblasts and osteoblasts. *Biomaterials* 1995; 16(13):987-92.
- (11) Invibio® Biomaterial Solutions. PEEK-OPTIMA® Natural - Typical Material Properties; 2013. Available from: URL: <https://invibio.com/materials/peek-optima-natural>
- (12) Chen Y, Wang X, Lu X, Yang L, Yang H, Yuan W et al. Comparison of titanium and polyetheretherketone (PEEK) cages in the surgical treatment of multilevel cervical spondylotic myelopathy: a prospective, randomized, control study with over 7-year follow-up. *Eur Spine J* 2013; 22(7):1539-46.
- (13) Macnair R, Rodgers EH, MacDonald C, Wykman A, Goldie I, Grant MH. The response of primary rat and human osteoblasts and an immortalized rat osteoblast cell line to orthopaedic materials: comparative sensitivity of several toxicity indices. *J Mater Sci Mater Med* 1997; 8(2):105-11.
- (14) Dr. Stuart Green, Keith Cartwright. An investigation into the effect of accelerated oxygen ageing on the properties of PEEK-OPTIMA®. March 2004. (B.DoCS-ID 21870982) Tensile, flex and impact specimens in PEEK-OPTIMA® were tested according to appropriate ISO standards (ISO 527, ISO 178 and ISO 180). A comparison was made between control PEEK-OPTIMA® and aged PEEK-OPTIMA® to investigate the effect of accelerated oxygen ageing on the material properties. Accelerated ageing was conducted exposing the specimens 40 days to 70°C oxygen at 5 bars pressure. The results show no significant effect on the mechanical properties of the PEEK polymer with the aged and control specimens showing similar values. The retention of good mechanical properties after the intense ageing cycle demonstrates that PEEK-OPTIMA® is very resistant to oxygen ageing.
- (15) Kuhn JL, Goldstein SA, Choi K, London M, Feldkamp LA, Matthews LS. Comparison of the trabecular and cortical tissue moduli from human iliac crests. *J Orthop Res* 1989; 7(6):876-84.

AESCULAP[®] – a B. Braun brand

Aesculap AG | Am Aesculap-Platz | 78532 Tuttlingen | Germany
Phone +49 7461 95-0 | Fax +49 7461 95-2600 | www.aesculap.com

The main product trademark "AESCULAP" and the product trademarks "Ennovate", "OrthoTray", "PLASMAPORE", "S⁴" and "TSPACE" are registered trademarks of Aesculap AG. "PEEK-OPTIMA" is a registered trademark of Invivio Biomaterial Solutions.

Subject to technical changes. All rights reserved. This brochure may only be used for the exclusive purpose of obtaining information about our products. Reproduction in any form partial or otherwise is not permitted.