



AESCULAP® Power Systems

Catalog 2025

ELAN 4 and Acculan 4

Content

ELAN 4

- › ELAN 4 electro
 - › ELAN 4 Accessories
-

Acculan 4

- › Acculan 4
 - › Acculan 4 Small Drill
 - › Acculan 4 Electro
 - › Acculan 4 Accessories
-

Processing

- › Sterilit® Power Systems
 - › Processing
-

Others

- › Overview of standardised tool shanks
 - › Signs & Symbols
 - › Brochures
 - › Index
-

AESCLAP® ELAN 4

Precision. Performance. Pleasure.

With its technical concept ELAN 4 addresses important requirements of the surgeon and all parties involved in handling power systems in the hospital.

- Convenient and reliable grip
- Powerful, precise and reliable work
- Easy to set up and simple to use*



*Usability validation tests for the different ELAN 4 handpieces and applied parts.

Proband's with different clinical experience confirmed easy and safe handling. User needs such as 1) Convenient and reliable grip; 2) Powerful, precise and reliable work and 3) Easy to set up and simple to use were also tested and approved by the probands with the different handpieces and applied parts.

AESCLAP® ELAN 4

ELAN 4 electro

Electric Highspeed System



ELAN 4 electro

Basic components

GA800

ELAN 4 electro control unit

with irrigation pump; touch screen;

pump flow 0–65 ml/min

100–240 V AC; 50/60 Hz;

380 x 330 x 200 mm; 9,500 g

consisting parts:

GD412804 bottle holder

power cord not included



GA808

ELAN 4 electro foot control

protection type IPX8; anaesthetic proof class AP

5.0 m;

245 x 144 x 76 mm; 2,240 g

consisting parts:

GA808207 rail



GA810

ELAN 4 electro wireless foot control

protection type IPX8; anaesthetic proof class AP

271 x 266 x 85 mm; 3,800 g

Requires control unit with software version V3.00.

consisting parts:

GA810202 rail

3 batteries Type D/LR20/Mono



GA806

GB073R

ELAN 4 electro motor cable

for use with ELAN 4 electro applied parts

4.0 m; 270 g

consisting parts:

GB600860 Sterilit® oil spray adapter

ELAN 4 electro



AESCULAP® ELAN 4

ELAN 4 electro

Basic components & perforator driver

GA804

GB073R

ELAN 4 electro motor cable with hand switch

for use with ELAN 4 electro applied parts

4.0 m; 374 g

consisting parts:
GB600860 Sterilit® oil spray adapter
ELAN 4 electro



GA805

GB073R

ELAN 4 electro motor cable with hand control

for use with ELAN 4 electro applied parts

4.0 m; 369 g

consisting parts:
GB600860 Sterilit® oil spray adapter
ELAN 4 electro



GA822

GB076R

ELAN 4 electro perforator driver

for use with cranial perforators with Hudson shank

180 W; 0 - 1,200 rpm; 250 Ncm;
166 x 35 mm; 410 g



ELAN 4 electro

Craniotome & attachments

GA849

GB085R

ELAN 4 electro craniotome and multifunction handpiece

2-ring burr coupling; for use with dura guards and holding sleeves GB941R - GB947R; spray nozzle GA259SU (not included)

140 W; ↻ ↺; 0 - 80,000 rpm; 2.2 Ncm; 156 x 17 mm; 📖 121 g



GB941R

GB719R

ELAN 4 dura guard pediatric

fixed; 1 dot coding; for craniotome and multifunction handpieces GA749, GA849

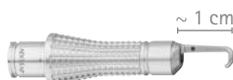

GB942R

GB719R

ELAN 4 dura guard standard

fixed; 2 dot coding; for craniotome and multifunction handpieces GA749, GA849



GB943R

GB719R

ELAN 4 dura guard long

fixed; 3 dot coding; for craniotome and multifunction handpieces GA749, GA849



GB945R

GB719R

ELAN 4 holding sleeve

for craniotome and multifunction handpieces GA749, GA849



GB947R

GB719R

ELAN 4 dura guard standard

turnable; 2 dot coding; for craniotome and multifunction handpieces GA749, GA849



AESCULAP® ELAN 4

ELAN 4 electro

1-ring highspeed handpieces

GA861

GB083R

ELAN 4 electro 1-ring handpiece L4

1-ring burr coupling;
spray nozzle GA261SU (not included)
140 W; ↗ ↘; 0 - 80,000 rpm; 2.2 Ncm;
152 x 16 mm; 80 g



GA862

GB083R

ELAN 4 electro 1-ring handpiece L7

1-ring burr coupling;
spray nozzle GA262SU (not included)
140 W; ↗ ↘; 0 - 80,000 rpm; 2.2 Ncm;
177 x 16 mm; 83 g



GA863

GB083R

ELAN 4 electro 1-ring handpiece L10

1-ring burr coupling;
spray nozzle GA263SU (not included)
140 W; ↗ ↘; 0 - 80,000 rpm; 2.2 Ncm;
206 x 16 mm; 87 g

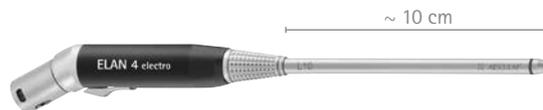

GA864

GB083R

ELAN 4 electro 1-ring handpiece L13

1-ring burr coupling;
spray nozzle GA264SU (not included)
140 W; ↗ ↘; 0 - 80,000 rpm; 2.2 Ncm;
237 x 16 mm; 91 g

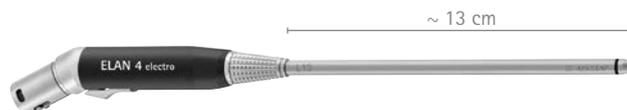

ELAN 4 electro

2-ring highspeed handpieces

GA865

GB083R

ELAN 4 electro 2-ring handpiece L7

2-ring burr coupling;
spray nozzle GA265SU (not included)
140 W; ↗ ↘; 0-80,000 rpm; 2.2 Ncm;
176 x 16 mm; 📖 89 g



GA866

GB083R

ELAN 4 electro 2-ring handpiece L10

2-ring burr coupling;
spray nozzle GA266SU (not included)
140 W; ↗ ↘; 0-80,000 rpm; 2.2 Ncm;
206 x 16 mm; 📖 95 g



GA867

GB083R

ELAN 4 electro 2-ring handpiece L13

2-ring burr coupling;
spray nozzle GA267SU (not included)
140 W; ↗ ↘; 0-80,000 rpm; 2.2 Ncm;
236 x 16 mm; 📖 100 g

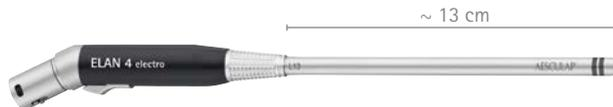

GA868

GB083R

ELAN 4 electro 2-ring handpiece L17

2-ring burr coupling;
spray nozzle GA268SU (not included)
140 W; ↗ ↘; 0-80,000 rpm; 2.2 Ncm;
276 x 16 mm; 📖 108 g



GA869

GB083R

ELAN 4 electro 2-ring handpiece L22

2-ring burr coupling;
spray nozzle GA269SU (not included)
140 W; ↗ ↘; 0-80,000 rpm; 2.2 Ncm;
326 x 16 mm; 📖 118 g



AESCULAP® ELAN 4

ELAN 4 electro

MIS handpiece & handpiece shafts



GA860

GB084R

ELAN 4 electro MIS handpiece

for use with MIS handpiece shafts
GB920R - GB927R

140 W; ↻ ↻; 0 - 80,000 rpm;
2.2 Ncm; 118 x 17 mm; ⚖ 100 g

consisting parts:

GB600870 Sterilit® spray adapter for
ELAN 4 MIS handpiece shafts



GB920R

GB723R

**ELAN 4 MIS handpiece shaft
L10 straight**

spray nozzle GB796SU (not included)



GB921R

GB723R

**ELAN 4 MIS handpiece shaft
L10 curved**

spray nozzle GB796SU (not included)



GB922R

GB723R

**ELAN 4 MIS handpiece shaft
L10 heavy curved**

spray nozzle GB796SU (not included)



GB925R

GB723R

**ELAN 4 MIS handpiece shaft
L13 straight**

spray nozzle GB797SU (not included)



GB926R

GB723R

**ELAN 4 MIS handpiece shaft
L13 curved**

spray nozzle GB797SU (not included)



GB927R

GB723R

**ELAN 4 MIS handpiece shaft
L13 heavy curved**

spray nozzle GB797SU (not included)



AESCULAP® ELAN 4

ELAN 4 electro

Lowspeed motor & 2.35 mm handpiece



GA816

GB078R

ELAN 4 2.35 mm handpiece

2.35 mm burr coupling:

spray nozzle GA271SU (not included)

140 W; ↻; 0 - 80,000 rpm; 2.2 Ncm;

147 x 16 mm 📏 120 g



GA824

GB077R

ELAN 4 electro lowspeed motor

with INTRA coupling

180 W; ↻; 0 - 40,000* rpm;

10 Ncm; 123 x 23 mm; 📏 150 g



* Requires control unit with software version V3.00. With lower versions the motor runs max. 20,000 rpm.

AESCLAP® ELAN 4

ELAN 4 electro
Saws



GA836

GB086R

ELAN 4 electro micro sagittal saw

spray nozzle GA258SU (not included)
180 W; 0 - 20,000 rpm; 161 x 23 mm;
 \sphericalangle 7°; \updownarrow 190 g

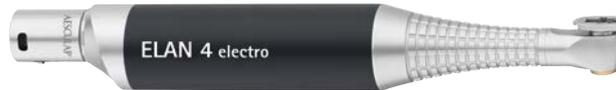

GA837

GB087R

ELAN 4 electro micro reciprocating saw

spray nozzle GA258SU (not included)
180 W; 0 - 20,000 rpm; 184 x 23 mm;
 \updownarrow 1.3 mm; \updownarrow 198 g



GA831

GB088R

ELAN 4 electro sagittal saw

spray nozzle GA258SU (not included)
180 W; 0 - 20,000 rpm; 129 x 23 mm;
 \sphericalangle 4.5°; \updownarrow 220 g



GA832

GB087R

ELAN 4 electro reciprocating saw

spray nozzle GA258SU (not included)
180 W; 0 - 20,000 rpm; 194 x 23 mm;
 \updownarrow 2.5 mm; \updownarrow 238 g



GA833

GB088R

ELAN 4 electro transversal saw

spray nozzle GA258SU (not included)
180 W; \swarrow \searrow ; 0 - 20,000 rpm; 10 Ncm;
130 x 23 mm; \sphericalangle 10°; \updownarrow 185 g
to be used with saw blade shafts
GP580R, GP582R, GP586R and GP590R



AESCULAP® ELAN 4

ELAN 4 electro
Drill



GA844

GB482R

ELAN 4 electro drill

with fixed motor cable, oscillating and tapping mode

200 W;  3.2 mm;
122 x 130 x 27 mm;  800 g

consisting parts:

GA344244 K-wire protection guide

TA011944 cleaning brush

GA344211 rinsing adapter

GB600880 Sterilit® spray adapter

Requires control unit with software version V3.00.



GB870R

GB716R

Intramedullary reamer attachment

with Jacobs chuck 0.5 - 7.4 mm,
not for use with acetabulum reamers

0 - 320 rpm; 6.5 Nm;  3.2 mm;
105 x 29 mm;  230 g

consisting parts:

key GA031R



GB871R

GB716R

Intramedullary reamer attachment

with large AO chuck,
not for use with acetabulum reamers

0 - 320 rpm; 6.5 Nm;  3.2 mm;
88 x 29 mm;  170 g



GB872R

GB716R

Intramedullary reamer attachment

with Hudson/Zimmer chuck,
not for use with acetabulum reamers

0 - 320 rpm; 6.5 Nm;  3.2 mm;
86 x 25 mm;  150 g



AESFULAP® ELAN 4

ELAN 4 electro

Drill

GB881R

GB716R

Drill attachment

with Jacobs chuck 0.5 - 7.4 mm

0 - 1,250 rpm; 2 Nm;  3.2 mm;
89 x 29 mm;  163 g

consisting parts:
key GA031R



GB882R

GB716R

Drill attachment

with Jacobs chuck 0.5 - 4 mm

0 - 1,250 rpm; 2 Nm;  3.2 mm;
76 x 22 mm;  100 g

consisting parts:
key GA062R



GB884R

GB716R

Drill attachment

with small AO chuck

0 - 1,250 rpm; 2 Nm;  2.8 mm;
60 x 22 mm;  66 g



GB886R

GB716R

Drill attachment

with AESFULAP® hexagonal chuck

0 - 1,250 rpm; 2 Nm;  3.2 mm;
57 x 24 mm;  67 g



GB887R

GB716R

Drill attachment

with Dental shank

0 - 1,250 rpm; 2 Nm;  1.8 mm;
56 x 22 mm;  50 g



GB878R

GB716R

Drill attachment

for Synthes radiolucent drive 511.300

0 - 1,250 rpm; 2 Nm;
111 x 27 mm; 181 g



GB894R

GB716R

K-wire attachment

for K-wires from 0.6 - 3.2 mm

0 - 1,250 rpm; 3.2 mm;
92 x 27 x 124 mm; 179 g



GB891R

GB716R

Sagittal saw attachment

for "L-sagittal" sawblades

0 - 15,750 rpm; 74 x 33.5 mm;
4.5°; 179 g



GB892R

GB716R

Reciprocating saw attachment

for reciprocating sawblades

0 - 15,750 rpm; 135 x 24.5 mm;
2.5 mm; 166 g



AESCULAP® ELAN 4

ELAN 4 electro Drill

GB896R

GB716R

Screw attachment

with small AO chuck

0 - 165 rpm; 12 Nm;  1.7 mm;
95 x 28 x 129.5 mm;  235 g



GB897R

GB716R

Screw attachment

with AESCULAP® hexagonal chuck

0 - 165 rpm; 12 Nm;  1.7 mm;
92 x 28 x 129.5 mm;  231 g



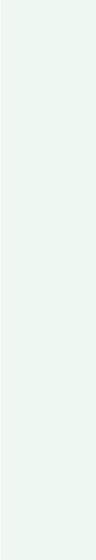

AESCLAP® ELAN 4

ELAN 4 accessories

GB861P

GB727R

ELAN 4 length reduction sleeve
for use with 1-ring handpieces



GB863P

GB727R

ELAN 4 length reduction sleeve
for use with 2-ring handpieces



GB862P

GB727R

ELAN 4 MIS sleeve
for use with 1-ring handpieces



GB866R

ELAN 4 lateral burr guard
for use with 1-ring handpieces and
burrs up to 4.5 mm diameter



TE780

Power cord
Europe, ⚡ 1.5 m

TE730

Power cord
Europe, ⚡ 5.0 m

TE734

Power cord
UK, ⚡ 5.0 m

TE735

Power cord
USA, Canada, Japan, ⚡ 3.5 m



GA395SU

sterile  

ELAN 4 electro disposable tube set
free from latex and phthalates



AESCULAP® ELAN 4

ELAN 4 accessories

ELAN 4 spray nozzels

sterile 

GA259SU

for craniotome attachments

GA261SU

for 1-ring handpiece L4

GA262SU

for 1-ring handpiece L7

GA263SU

for 1-ring handpiece L10

GA264SU

for 1-ring handpiece L13

GA265SU

for 2-ring handpiece L7

GA266SU

for 2-ring handpiece L10

GA267SU

for 2-ring handpiece L13

GA268SU

for 2-ring handpiece L17

GA269SU

for 2-ring handpiece L22

GB796SU

for MIS handpiece shafts L10

GB797SU

for MIS handpiece shafts L13

GA271SU

for 2.35 mm handpiece

GA258SU

for saws



AESCULAP® Acculan 4

Look. Feel. Experience.

Acculan 4 the battery-operated power system for orthopaedics, traumatology, cardiothoracic surgery and dermatology

- Powerful
- Longevity – Exclusion of battery and electronic control from sterilization process
- Easy handling – Titanium housing allows mechanical alkaline reprocessing*

Acculan 4



*Usability validation tests for the different Acculan 4 products and applied parts.

Probands with different clinical experience confirmed safe handling. User needs such as 1) Powerful work; 2) Longevity and 3) Easy handling were also approved by the probands with the different drills and applied parts.

AESCULAP® Acculan 4

Drill

GA330

GB495R

Acculan 4 drill and reamer

250 W; ↻ ↺; 4.0 mm;
207 x 121 x 55 mm; 1,250 g

consisting parts:

GA678 sterile funnel

GA672207 K-wire protection sleeve

TA011944 cleaning brush

GA672211 rinsing adapter

GB600840 Sterilit® oil spray adapter

Acculan

Lid GA675 and NiMH battery GA676 to be ordered separately.

Measurements and weight are including battery and lid.



GB620R

GB496R

Acculan 4 drill attachment

with Jacobs chuck 0.5 - 7.4 mm

0 - 1,000 rpm; 5.0 Nm; 4.0 mm;
133 x 35 mm; 397 g

consisting parts:

key GA031R



GB621R

GB496R

Acculan 4 drill attachment

with Jacobs chuck 0.5 - 7.4 mm

0 - 1,000 rpm; 5.0 Nm; 4.0 mm;
118 x 35 mm; 300 g

consisting parts:

key GA031R



GB623R

GB496R

Acculan 4 drill attachment

with small AO chuck

0 - 1,250 rpm; 4.0 Nm; 2.8 mm;
90 x 35 mm; 210 g



GB645R

GB496R

Acculan drill attachment

for Synthes radiolucent drive 511.300

0 - 900 rpm; 110 x 35 mm; 225 g



GB663R

GB496R

Acculan 4 drill attachment

with trinkle chuck

0 - 1,000 rpm; 5.0 Nm; 4.0 mm;

93 x 35 mm; 217 g



GB664R

GB496R

Acculan 4 drill attachment

with AESCULAP® hexagonal chuck

0 - 1,000 rpm; 5.0 Nm; 4.0 mm;

86 x 35 mm; 225 g



GB665R

GB496R

Acculan 4 drill attachment

with Hudson / Zimmer chuck

0 - 1,000 rpm; 5.0 Nm; 4.0 mm;

100 x 35 mm; 230 g



GB657R

GB496R

Acculan 4 intramedullar attachment

with large AO chuck

0 - 370 rpm; 12.0 Nm; 4.0 mm;

108 x 35 mm; 300 g



AESFULAP® Acculan 4

Drill

GB667R

GB496R

Acculan 4 reamer attachment

with Jacobs chuck 0.5 - 7.4 mm chuck

0 - 250 rpm; 19.0 Nm;  4.0 mm;
133 x 35 mm;  280 g

consisting parts:
key GA031R



GB668R

GB496R

Acculan 4 reamer attachment

with large AO chuck

0 - 250 rpm; 19.0 Nm;  4.0 mm;
108 x 35 mm;  300 g



GB669R

GB496R

Acculan 4 reamer attachment

with Hudson/Zimmer chuck

0 - 250 rpm; 19.0 Nm;  4.0 mm;
118 x 35 mm;  300 g



GB670R

GB496R

Acculan 4 reamer attachment

with Harris chuck

0 - 250 rpm; 19.0 Nm;  4.0 mm;
106 x 35 mm;  290 g



GB660R

GB496R

Acculan sagittal saw attachment

for Acculan rapid action saw blades
with a maximum useable length of
50 mm

↔ 0 - 17,000 rpm; $\leq 4^{\circ}47'$;
89 x 36 x 44 mm;  270 g



GB641R

GB496R

Acculan K-wire attachment

for K-wires from 0.6 - 4.0 mm

0 - 1,250 rpm; 93 x 36 x 137 mm;

285 g



AESCULAP® Acculan 4

Oscillating saws

GA331

GB495R

Acculan 4 oscillating saw

250 W; \leftrightarrow 0 - 13,000 rpm; \sphericalangle 4.1°;
211 x 177 x 55 mm; \updownarrow 1,600 g

consisting parts:
GA678 sterile funnel

Lid GA675 and NiMH battery GA676 to
be ordered separately.

Measurements and weight are including
battery and lid.



GA336

GB498R

Acculan 4 oscillating saw straight

250 W; \leftrightarrow 0 - 13,000 rpm; \sphericalangle 4.1°;
290 x 55 x 84 mm; \updownarrow 1,480 g

consisting parts:
GA678 sterile funnel

Lid GA675 and NiMH battery GA676 to
be ordered separately.

Measurements and weight are including
battery and lid.



GA337

GB498R

Acculan 4 oscillating sternum saw

250 W; \leftrightarrow 0 - 13,000 rpm; \sphericalangle 4.1°;
290 x 55 x 84 mm; \updownarrow 1,480 g

consisting parts:
GA678 sterile funnel

Lid GA675 and NiMH battery GA676 to
be ordered separately.

Measurements and weight are including
battery and lid.



Reciprocating saw

GA334

GB495R

Acculan 4 reciprocating saw

250 W; ↔ 0 - 15,000 rpm; ↓ 3.2 mm;
207 x 180 x 55 mm; ⚖ 1,540 g

consisting parts:

GA678 sterile funnel

GB440215 cleaning plate

GA674890 cleaning adapter

Lid GA675 and NiMH battery GA676 to
be ordered separately.

Measurements and weight are including
battery and lid.



GB436R

GB686R

Protection guide

for use with GA334 and saw blade
GC761R



AESCULAP® Acculan 4

Dermatome

GA340

GB498R

Acculan 4 dermatome

width keyless adjustable;
thickness adjustable (1 / 10 mm steps);
cutting thickness: 0.2 - 1.2 mm;
cutting width: max. 78 mm;
suitable blades: GB228R
(to be ordered separately)

250 W; ↔ 0 - 6,500 rpm; ↑↓ 3.1 mm;
277 x 113 x 83 mm; ⚖ 1,650 g

consisting parts:
GA678 sterile funnel

Lid GA675 and small Li-Ion battery
GA346 to be ordered separately.

Measurements and weight are including
battery and lid.



GA341

GB498R

Acculan 4 dermatome 0.1 mm

width keyless adjustable;
thickness adjustable (1 / 10 mm steps);
cutting thickness: 0.1 - 1.1 mm;
cutting width: max. 78 mm;
suitable blades: GB228R
(to be ordered separately)

250 W; ↔ 0 - 6,500 rpm; ↑↓ 3.1 mm;
277 x 113 x 83 mm; ⚖ 1,650 g

consisting parts:
GA678 sterile funnel

Lid GA675 and small Li-Ion battery
GA346 to be ordered separately.

Measurements and weight are including
battery and lid.



BA720R

GB688R

Skin graft mesher

for use in combination with skin graft
carrier plates BA721, BA722, BA723
(factors 1.5, 3.0, 6.0)

150 x 195 x 105 mm; ⚖ 4,800 g

consisting parts:
BA725R cutting roller
BA726R ratchet wrench



AESCULAP® Acculan 4

Look. Feel. Experience.

Acculan 4 small drill – the smallest member of the Acculan 4 family can be used for small fragment Osteosynthesis as well as for reamed intramedullary nailing.



AESCULAP® Acculan 4

Small drill

GA344

GB482R

Acculan 4 small drill

with oscillating and tapping mode;
not for use with acetabulum reamers

85 W;  3.2 mm;
177 x 124 x 55 mm;  840 g

consisting parts:

GA678 sterile funnel

GA344244 K-wire protection guide

TA011944 cleaning brush

GA344211 rinsing adapter

GB600880 Sterilit® spray adapter

Lid GA675 and small Li-Ion battery
GA346 to be ordered separately.

Measurements and weight are including
battery and lid.



GB870R

GB716R

Intramedullary reamer attachment

with Jacobs chuck 0.5 - 7.4 mm,
not for use with acetabulum reamers

0 - 320 rpm; 5 Nm;  3.2 mm;
105 x 29 mm;  230 g

consisting parts:

key GA031R



GB871R

GB716R

Intramedullary reamer attachment

with large AO chuck,
not for use with acetabulum reamers

0 - 320 rpm; 5 Nm;  3.2 mm;
88 x 29 mm;  170 g



GB872R

GB716R

Intramedullary reamer attachment

with Hudson/Zimmer chuck,
not for use with acetabulum reamers

0 - 320 rpm; 5 Nm;  3.2 mm;
86 x 25 mm;  150 g



GB881R

GB716R

Drill attachment

with Jacobs chuck 0.5 - 7.4 mm

0 - 1,250 rpm; 1.5 Nm;  3.2 mm;
89 x 29 mm;  163 g

consisting parts:
key GA031R



GB882R

GB716R

Drill attachment

with Jacobs chuck 0.5 - 4 mm

0 - 1,250 rpm; 1.5 Nm;  3.2 mm;
76 x 22 mm;  100 g

consisting parts:
key GA062R



GB884R

GB716R

Drill attachment

with small AO chuck

0 - 1,250 rpm; 1.5 Nm;  2.8 mm;
60 x 22 mm;  66 g



GB886R

GB716R

Drill attachment

with AESCULAP® hexagonal chuck

0 - 1,250 rpm; 1.5 Nm;  3.2 mm;
57 x 24 mm;  67 g



GB887R

GB716R

Drill attachment

with Dental shank

0 - 1,250 rpm; 1.5 Nm;  1.8 mm;
56 x 22 mm;  50 g



AESCULAP® Acculan 4

Small drill

GB878R

GB716R

Drill attachment

for Synthes radiolucent drive 511.300

0 - 1,250 rpm; 1.5 Nm;
111 x 27 mm; 181 g



GB894R

GB716R

K-wire attachment

for K-wires from 0.6 - 3.2 mm

0 - 1,250 rpm; 3.2 mm;
92 x 27 x 124 mm; 179 g



GB891R

GB716R

Sagittal saw attachment

for "L-sagittal" sawblades

0 - 15,750 rpm; 74 x 33.5 mm;
4.5°; 179 g



GB892R

GB716R

Reciprocating saw attachment

for reciprocating saw blades

0 - 15,750 rpm; 135 x 24.5 mm;
166 g; 2.5 mm



GB896R

GB716R

Screw attachment

with small AO chuck

0 - 165 rpm; 10 Nm;  1.7 mm;
95 x 28 x 129.5 mm;  235 g



GB897R

GB716R

Screw attachment

with AESCULAP® hexagonal chuck

0 - 165 rpm; 10 Nm;  1.7 mm;
92 x 28 x 129.5 mm;  231 g



AESCULAP® Acculan 4

Charger & batteries

GA320

Acculan 4 charger

for Acculan Li-Ion and NiMH batteries
GA346, GA676; 4 charging bays;
automatic battery diagnosis function
100 - 240 V AC; 50 / 60 Hz;
410 x 120 x 160 mm; 2,300 g
power cord not included



GA346

Acculan 4 Li-Ion battery short

only for GA340, GA341 and GA344;
with integrated electronic motor
control 9.9 V; 11.88 Wh
120 x 43 x 50 mm; 265 g



GA676

Acculan NiMH battery

only for GA330, GA331, GA334, GA336,
GA337; with integrated electronic
motor control 9.6 V; 1.95 Ah
140 x 43 x 50 mm; 425 g



GA679

GB489R

Acculan battery removal device



GA675

GB487R

Acculan lid

90 g



GA678

GB488R

Acculan sterile funnel



AESCULAP® Acculan 4 Electro

Look. Feel. Experience.

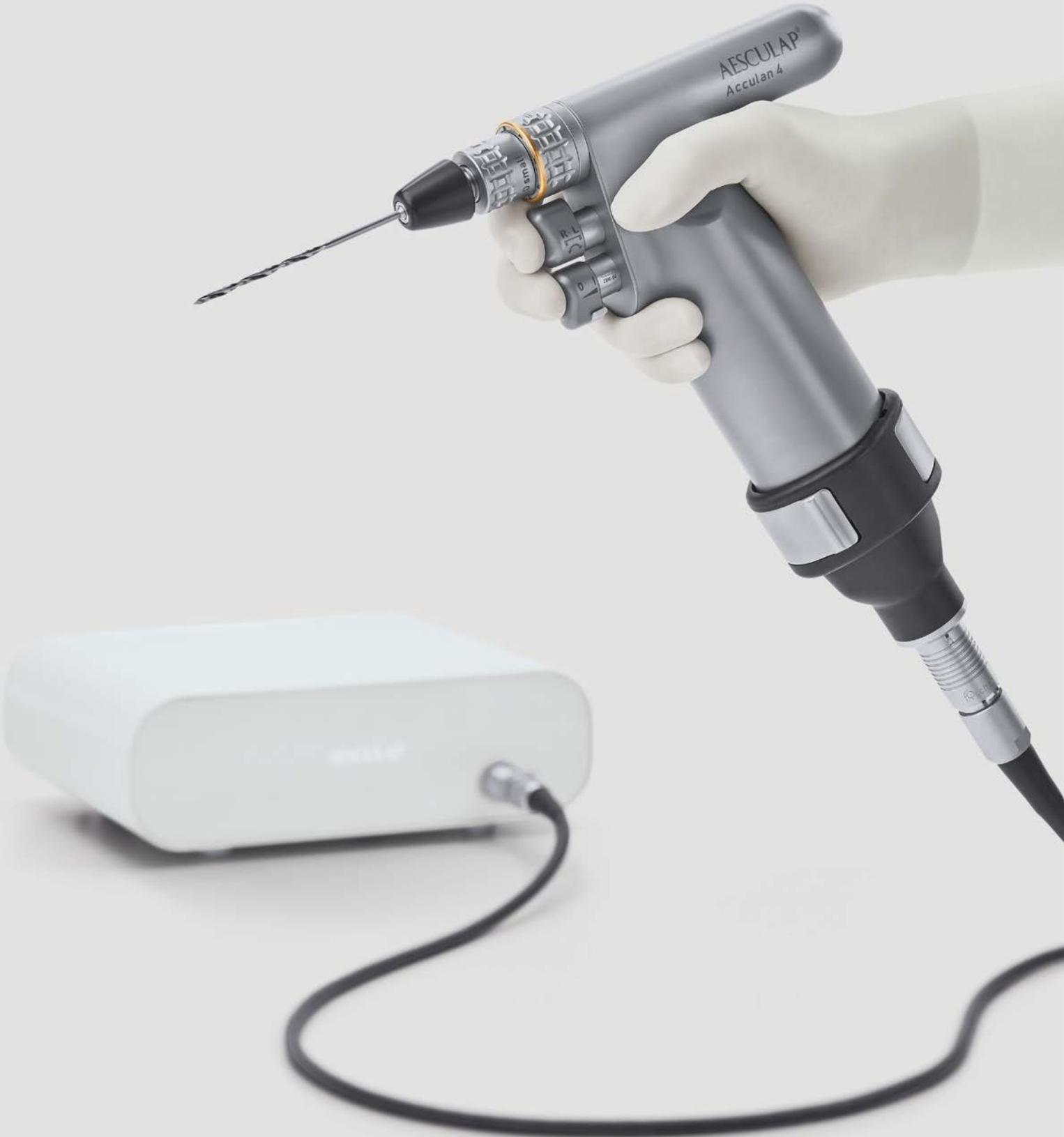

Console & accessories

GA877

Acculan Electro console

power cord not included

100 - 240 V AC; 50 / 60 Hz;
255 x 217 x 90 mm; 2,930 g



GA878

GB486R

Acculan Electro connection cable
for use with Acculan 4 handpieces

3.0 m; 410 g



GA875

GB485R

Acculan Electro lid



GA876

Acculan Electro adapter

120 x 49 x 42 mm; 165 g



GA678

GB488R

Acculan sterile funnel



AESFULAP® Acculan 4 Accessories

Adapters, keys & power cord

<p>GB176R GB690R</p> <p>Zimmer adapter tool: Zimmer motor: Hudson/Zimmer only in combination with GB630R, GB656R, GB665R, GB669R or GB872R  3.0 mm</p>	<p>GB414R JG344</p> <p>AESFULAP® hex adapter tool: AESFULAP® hexagonal motor: triangular  3.5 mm</p>	<p>GB628R JG344</p> <p>Synthes DHS/DCS adapter tool: Synthes DHS/DCS motor: AO large  4.0 mm</p>
		
<p>GB184R JG344</p> <p>Harris adapter tool: Harris motor: AO large  3.4 mm</p>	<p>XF457R JG344</p> <p>DIN adapter tool: DIN motor: AO large  3.7 mm</p>	<p>GA031R JG342 + JG344</p> <p>Key for large Jacobs chuck suitable for GB620R, GB621R, GB667R, GB870R, GB881R</p>
		
<p>GA062R JG342</p> <p>Key for small 4 mm Jacobs chuck suitable for GB639R, GB882R</p>		
		
<p>TE780</p>	<p>TE734</p>	
<p>Power cord Europe,  1.5 m</p>	<p>Power cord UK,  5.0 m</p>	
<p>TE730</p>	<p>TE735</p>	
<p>Power cord Europe,  5.0 m</p>	<p>Power cord USA, Canada, Japan,  3.5 m</p>	

AESCULAP® Processing

Sterilit® power systems



AESCLAP® Processing

Sterilit® power systems

GB600



Sterilit® power systems
oil spray; 300 ml



GB600860

Sterilit® power systems spray
adapter

for ELAN 4 electro



GB600870

Sterilit® power systems spray
adapter

for ELAN 4 MIS handpiece shafts



GB600840

Sterilit® power systems spray
adapter

for Acculan 4



GB600880

Sterilit® power systems spray
adapter

for Acculan 4 small drill and ELAN 4
electro drill



AESCULAP® Mechanical Processing

- The solution for storage and mechanical reprocessing of our AESCULAP® Power Systems.
- For detailed information please refer to the instructions for use.



AESCULAP® Mechanical Processing

ECCOS® sets

ELAN 4 electro

GB261R

ELAN 4 electro ECCOS® set

 56 mm

consisting parts:

GB073R

GB076R

GB083R

GB085R

GB719R

GB072R

JF212R

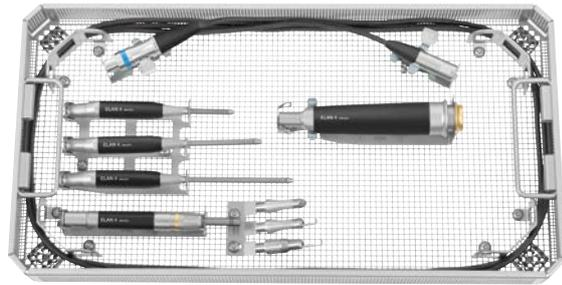

GB262R

ELAN 4 electro ECCOS® set for drill GA844

 106 mm

consisting parts:

GB072R

GB073R

GB482R

GB715R

GB716R

2x GB690R

JG342

JG344

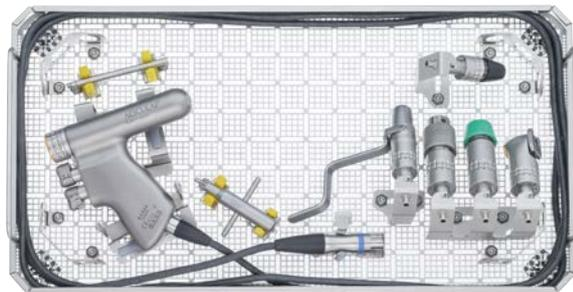

ECCOS®

ELAN 4 electro

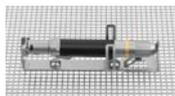
<p>GB073R</p> <p>ECCOS® holder for motor cable GA804, GA805, GA806 (set consisting of 2 pieces)</p>  56 mm	<p>GB076R</p> <p>ECCOS® holder for perforator driver GA822</p>  56 mm	<p>GB077R</p> <p>ECCOS® holder for intra motor GA824</p>  56 mm
 	 	 
<p>GB078R</p> <p>ECCOS® holder for 2.35 mm handpiece GA816</p>  56 mm	<p>GB082R</p> <p>ECCOS® holder for 1 handpiece</p>  56 mm	<p>GB083R</p> <p>ECCOS® holder for 3 handpieces</p>  56 mm
 	 	 
<p>GB084R</p> <p>ECCOS® holder for MIS handpiece GA860</p>  56 mm	<p>GB085R</p> <p>ECCOS® holder for craniotome GA849</p>  56 mm	<p>GB723R</p> <p>ECCOS® holder for MIS handpiece shafts GB920R - GB927R</p>  56 mm
 	 	 

AESCULAP® Mechanical Processing

ECCOS®

ELAN 4 electro

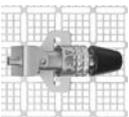
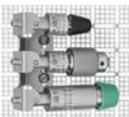
<p>GB086R</p>	<p>GB087R</p>	<p>GB088R</p>
<p>ECCOS® holder for micro sagittal saw GA836  56 mm</p>	<p>ECCOS® holder for reciprocating saws GA832, GA837  56 mm</p>	<p>ECCOS® holder for saws GA831, GA833  56 mm</p>
		
		
<p>GB482R</p>	<p>GB715R</p>	<p>GB716R</p>
<p>ECCOS® holder for ELAN 4 electro drill GA844  106 mm</p>	<p>ECCOS® holder for 1 attachment GB870R, GB871R, GB872R, GB878R, GB881R, GB884R, GB892R, GB896R, GB897R  106 mm</p>	<p>ECCOS® holder for 3 attachments GB870R, GB871R, GB872R, GB878R, GB881R, GB884R, GB892R, GB896R, GB897R  106 mm</p>
		
		

Rinsing devices & adapter

ELAN 4 electro

GB692R

Rinsing device

for applied parts, incl. ceramic filter GB693 
(not suitable for autoclaving)

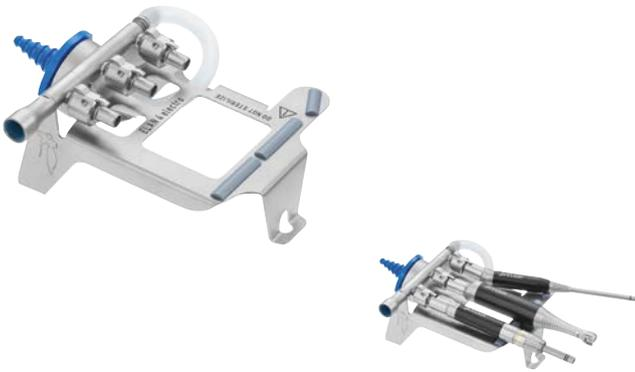

GB679R

Rinsing device

for 4 MIS shafts, incl. ceramic filter GB693 
(not suitable for autoclaving)

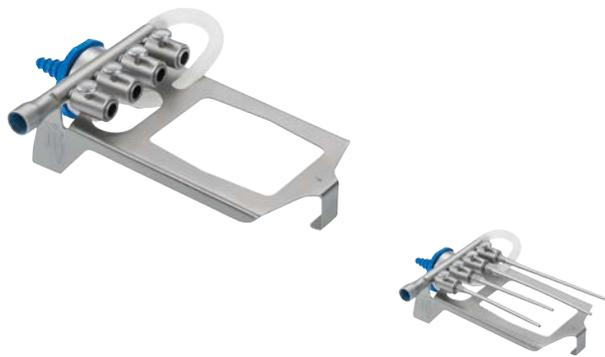

GB698R

Rinsing adapter

for applied parts
(for manual cleaning)



GB699R

Rinsing adapter

for MIS shafts
(for manual cleaning)



AESCULAP® Mechanical Processing

ECCOS®

ELAN 4 accessories

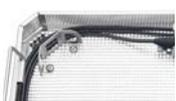
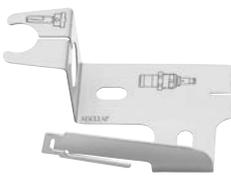
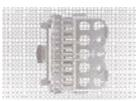
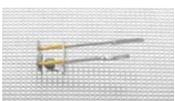
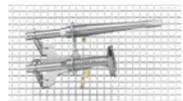
<p>GB072R</p> <p>ECCOS® cable/hose pos. guide for cable and hoses (set of 4 pieces)</p>  56 mm	<p>GB572R</p> <p>ECCOS® fixation for GB300R - GB304R</p>  56 mm	<p>GB719R</p> <p>ECCOS® holder for 3 craniotome attachments</p>  56 mm
 	 	 
<p>GB718R</p> <p>ECCOS® holder for 12 1- and 2-ring burrs</p>  56 mm	<p>GB613R</p> <p>ECCOS® universal holder for 13 2.35 mm burrs</p>  56 mm	<p>GB720R</p> <p>ECCOS® universal holder for saw blades</p>  56 mm
 	 	 
<p>GB727R</p> <p>ECCOS® holder for handpiece holding-sleeves GB861P, GB862P, GB863P</p>  56 mm	<p>GB729R</p> <p>ECCOS® holder for 2 reciprocating saw shafts</p>  56 mm	<p>GB730R</p> <p>ECCOS® holder for 2 transversal saw shafts</p>  56 mm
 	 	 

ECCOS® sets

Acculan 4

GB257R

ECCOS® set

for Acculan 4 small drill GA344

 106 mm

consisting parts:

GB482R

GB487R

GB488R

GB715R

GB716R

2x GB690R

JG342

JG344

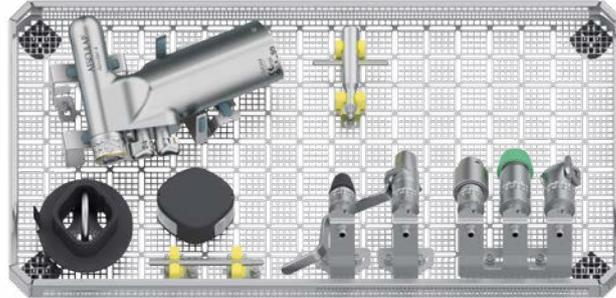

GB243R

ECCOS® set

for 2 Acculan 4 machines

 106 mm

consisting parts:

GB481R

GB487R

GB488R

GB495R

GB496R

GB497R

2x GB690R

JG342

JG344

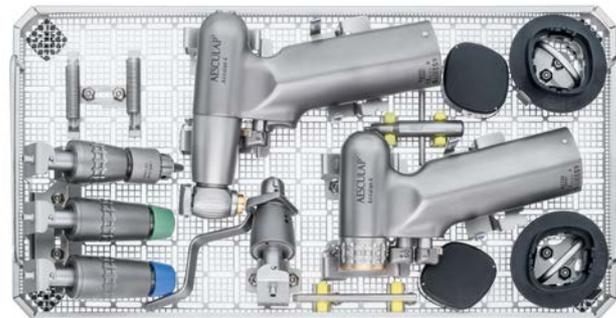

GB256R

ECCOS® set

for Acculan 4 dermatome

 106 mm

consisting parts:

GB487R

GB488R

GB498R

JJ464R



AESCULAP® Mechanical Processing

ECCOS®

Acculan 4

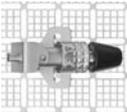
GB482R	GB715R	GB716R
<p>ECCOS® holder for Acculan 4 small drill GA344</p>  106 mm	<p>ECCOS® holder for 1 attachment GB870R, GB871R, GB872R, GB878R, GB881R, GB884R, GB892R, GB896R, GB897R</p>  106 mm	<p>ECCOS® holder for 3 attachments GB870R, GB871R, GB872R, GB878R, GB881R, GB884R, GB892R, GB896R, GB897R</p>  106 mm
 	 	 
GB495R	GB496R	GB497R
<p>ECCOS® holder for GA330, GA331, GA334</p>  106 mm	<p>ECCOS® holder for GB620R, GB621R, GB623R, GB641R, GB645R, GB660R, GB663R, GB664R, GB665R, GB657R, GB667R, GB668R, GB669R, GB670R</p>  106 mm	<p>ECCOS® holder for GB620R, GB621R, GB623R, GB641R, GB645R, GB660R, GB663R, GB664R, GB665R, GB657R, GB667R, GB668R, GB669R, GB670R</p>  106 mm
 	 	 

GB487R	GB488R	GB489R
---------------	---------------	---------------

ECCOS® holder
for GA675

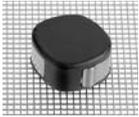

ECCOS® holder
for GA678



ECCOS® holder
for GA679



GB498R	GB686R
---------------	---------------

ECCOS® holder
for GA336, GA337, GA340, GA341

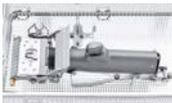

ECCOS® holder
for GB436R



AESCULAP® Mechanical Processing

ECCOS®

Acculan 4

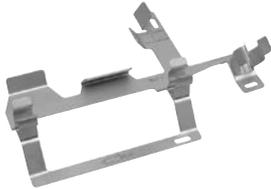
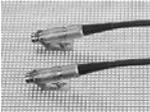
GB485R	GB486R	GB688R
<p>ECCOS® holder for GA875</p>  56 mm	<p>ECCOS® holder for GA878</p>  56 mm	<p>ECCOS® holder for BA720R</p>  106 mm
		
		
GB481R	JF148R	
<p>ECCOS® holder for saw blades and other accessories</p>  56 mm	<p>Mini tray with lid outer size: 145 x 44 x 25 mm inner size: 140 x 39 x 18 mm for storage of Acculan 4 Dermatome rod and flaps during automatic cleaning process</p>	
 		

ECCOS®

Universal tools

<p>GB459R</p> <p>ECCOS® & Aesculap InOS® mounting kit consisting of: socket wrench AF7 and hex-wrench</p>	<p>GB690R</p> <p>ECCOS® holder 5 mm for drilling wire guide GA672207, GA344244</p>	<p>JG303R </p> <p>Replacement screws-set screw nut size AF7</p>
		
<p>JG342</p> <p>Silicone clamp 8.5 mm screw JG303R to be ordered separately</p>	<p>JG344</p> <p>Silicone clamp 12 mm screw JG303R to be ordered separately</p>	
		

AESFULAP® Power Systems

Overview of standardised tool shanks

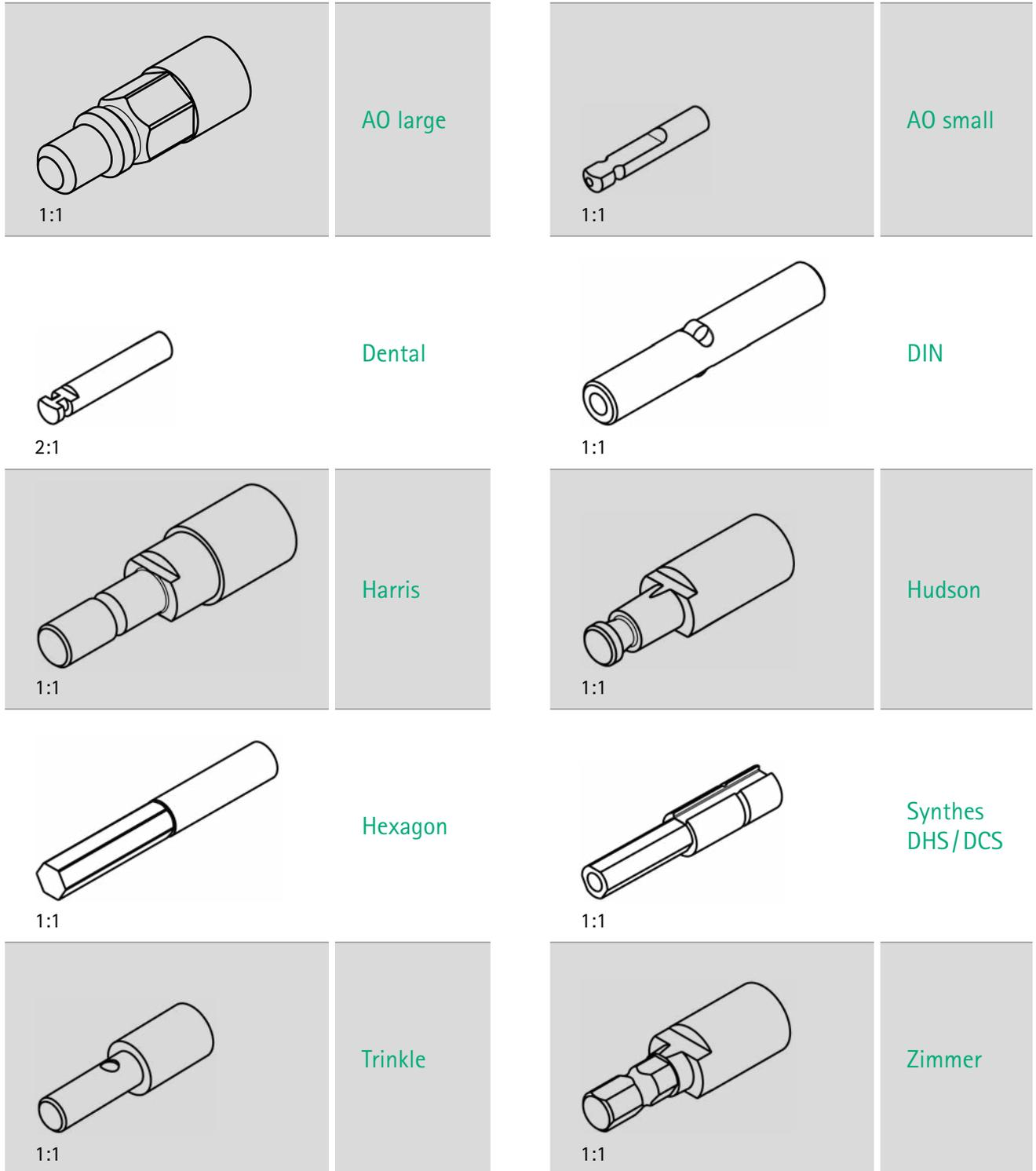

Signs & symbols

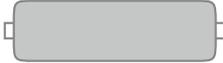
	<p>Latex-free All products listed in this catalog are latex-free</p>
	<p>Article code ECCOS® fixation</p>
	<p>Forward / reverse drive</p>
	<p>Forward drive</p>
	<p>Oscillation frequency</p>
	<p>Oscillation angle</p>
	<p>Stroke</p>
	<p>Cannulation</p>
	<p>Cable length</p>
	<p>Weight</p>
	<p>Packaging unit</p>
	<p>Single use</p>
	<p>Required height of tray</p>
	<p>Sterile</p>

AESCULAP® Power Systems

Brochures

Main Catalogs

084002
Power Systems

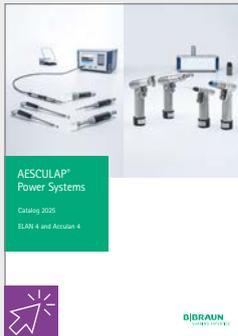

017599
Burs & Blades



CLICK HERE
for Electronic Instructions for Use (eIFU)

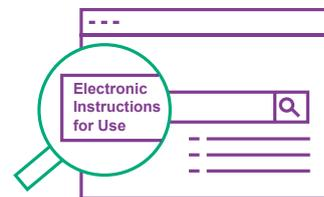

ELAN 4

071602
ELAN 4

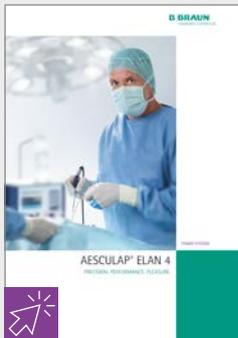

071511
Mechanical Cleaning



012002
Manual Cleaning



Acculan 4

001802
Acculan 4



001902
Acculan 4 dermatome



002002
Acculan 4 Electro

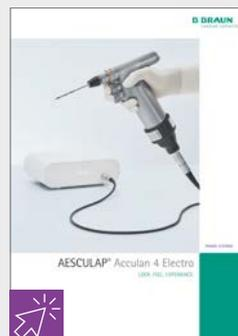

002102
Acculan 4 sternum saws

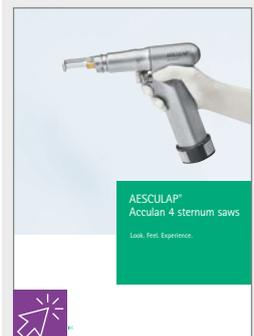

Index

Art. No.	
BA720R	34
GA031R	44
GA062R	44
GA258SU	26
GA259SU	26
GA261SU	26
GA262SU	26
GA263SU	26
GA264SU	26
GA265SU	26
GA266SU	26
GA267SU	26
GA268SU	26
GA269SU	26
GA271SU	26
GA320	40
GA330	28
GA331	32
GA334	33
GA336	32
GA337	32
GA340	34
GA341	34
GA344	36
GA346	40
GA395SU	25
GA675	40
GA676	40
GA678	40, 43
GA679	40
GA800	7
GA804	8
GA805	8
GA806	7
GA808	7
GA810	7
GA816	15
GA822	8
GA824	15
GA831	17
GA832	17
GA833	17
GA836	17
GA837	17
GA844	19
GA849	9
GA860	13
GA861	10
GA862	10
GA863	10

Art. No.	
GA864	10
GA865	11
GA866	11
GA867	11
GA868	11
GA869	11
GA875	43
GA876	43
GA877	43
GA878	43
GB072R	52
GB073R	49
GB076R	49
GB077R	49
GB078R	49
GB082R	49
GB083R	49
GB084R	49
GB085R	49
GB086R	50
GB087R	50
GB088R	50
GB176R	44
GB184R	44
GB243R	53
GB256R	53
GB257R	53
GB261R	48
GB262R	48
GB414R	44
GB436R	33
GB459R	57
GB481R	56
GB482R	50
GB482R	54
GB485R	56
GB486R	56
GB487R	55
GB488R	55
GB489R	55
GB495R	54
GB496R	54
GB497R	54
GB498R	55
GB572R	52
GB600	46
GB600840	46
GB600860	46
GB600870	46
GB600880	46

Art. No.	
GB613R	52
GB620R	28
GB621R	28
GB623R	28
GB628R	44
GB641R	31
GB645R	29
GB657R	29
GB660R	30
GB663R	29
GB664R	29
GB665R	29
GB667R	30
GB668R	30
GB669R	30
GB670R	30
GB679R	51
GB686R	55
GB688R	56
GB690R	57
GB692R	51
GB698R	51
GB699R	51
GB715R	50, 54
GB716R	50, 54
GB718R	52
GB719R	52
GB720R	52
GB723R	49
GB727R	52
GB729R	52
GB730R	52
GB796SU	26
GB797SU	26
GB861P	24
GB862P	24
GB863P	24
GB866R	24
GB870R	19, 36
GB871R	19, 36
GB872R	19, 36
GB878R	21, 38
GB881R	20, 37
GB882R	20, 37
GB884R	20, 37
GB886R	20, 37
GB887R	20, 37
GB891R	21, 38
GB892R	21, 38
GB894R	21, 38

Art. No.	
GB896R	22, 39
GB897R	22, 39
GB920R	13
GB921R	13
GB922R	13
GB925R	13
GB926R	13
GB927R	13
GB941R	9
GB942R	9
GB943R	9
GB945R	9
GB947R	9
JF148R	56
JF212R	48
JG303R	57
JG342	57
JG344	48, 57
TE730	24, 44
TE734	24, 44
TE735	24, 44
TE780	24, 44
XF457R	44

AESCULAP® – a B. Braun brand

Aesculap AG | Am Aesculap-Platz | 78532 Tuttlingen | Germany
Phone +49 7461 95-0 | www.aesculap.com

The main product trademark "AESCULAP" and the product trademarks "Aesculap InOS", "ECCOS" and "Sterilit" are registered trademarks of Aesculap AG.

Subject to technical changes. All rights reserved. This brochure may only be used for the exclusive purpose of obtaining information about our products. Reproduction in any form partial or otherwise is not permitted.